

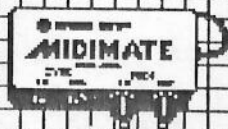

Hybrid Arts™ Inc.
11500 W. Olympic Blvd., L.A., Ca. 90064
(818) 826-8777



Professional Midi Products
Professional Midi Products

MIDITRACK III™

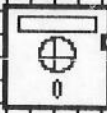
For the  **ATARI® 130XE**

THE UNIVERSITY OF CHICAGO
DEPARTMENT OF CHEMISTRY

PHYSICAL CHEMISTRY
BY
ROBERT W. HARRIS

PHYSICAL CHEMISTRY
BY
ROBERT W. HARRIS

PHYSICAL CHEMISTRY
BY
ROBERT W. HARRIS

PHYSICAL CHEMISTRY
BY
ROBERT W. HARRIS

HYBRID ARTS LICENSE AGREEMENT

IMPORTANT READ BEFORE OPENING THIS PACKAGE. THE SOFTWARE, HARDWARE, AND OWNERS MANUAL (SYSTEM) CONTAINED HEREIN IS LICENSED IN ACCORDANCE WITH THE FOLLOWING TERMS AND CONDITIONS.

Hybrid Arts grants to you a personal license to use the enclosed Hybrid Arts System solely for your own internal needs.

LICENSE

You May:

- a. use the system on a single machine;
- b. copy the program into any machine-readable or printable form for backup or modification purposes in support of your use of the program on the single machine (Certain programs, however, may include mechanisms to limit or inhibit copying. They are marked "copy protected").
- c. transfer the program and license to another party if the party agrees to accept the terms and conditions of this Agreement. If you transfer the program, you must at the same time either transfer all copies whether in printed or machine-readable form to the same party or destroy any copies not transferred; this includes all modifications and portions of the program contained or merged into other programs.

You must reproduce and include the copyright notice on any copy, modification or portion merged into another program.

YOU MAY NOT USE, COPY, MODIFY, OR TRANSFER THE SYSTEM, OR ANY COPY, MODIFICATION OR MERGED PORTION, IN WHOLE OR IN PART, EXCEPT AS EXPRESSLY PROVIDED FOR IN THIS LICENSE.

IF YOU TRANSFER POSSESSION OF ANY COPY, MODIFICATION OR MERGED PORTION OF THE SYSTEM TO ANOTHER PARTY, YOUR LICENSE IS AUTOMATICALLY TERMINATED.

TERM

The license is effective until terminated. You may terminate it at any other time by destroying the system together with all copies, modifications and merged portions in any form. It will also terminate upon conditions set forth elsewhere in this Agreement or if you fail to comply with any terms or conditions of this Agreement. You agree upon such termination to destroy the system together with all copies, modifications and merged portions in any form.

LIMITED WARRANTY

THE SYSTEM IS PROVIDED "AS IS" WITHOUT WARRANTY OF ANY KIND, EITHER EXPRESSED OR IMPLIED, INCLUDING, BUT NOT LIMITED TO THE IMPLIED WARRANTIES OF MERCHANTABILITY AND FITNESS FOR A PARTICULAR PURPOSE. THE ENTIRE RISK AS TO QUALITY AND PERFORMANCE OF THE SYSTEM IS WITH YOU. SHOULD THE SYSTEM PROVE DEFECTIVE, YOU (AND NOT HYBRID ARTS OR AN AUTHORIZED DEALER) ASSUME THE ENTIRE COST OF ALL NECESSARY SERVICING, REPAIR OR CORRECTION.

SOME STATES DO NOT ALLOW THE EXCLUSION OF IMPLIED WARRANTIES, SO THE ABOVE EXCLUSION MAY NOT APPLY TO YOU. THIS WARRANTY GIVES YOU SPECIFIC LEGAL RIGHTS AND YOU MAY ALSO HAVE OTHER RIGHTS WHICH VARY FROM STATE TO STATE.

Hybrid Arts does not warrant that the functions contained in the system will meet your requirements or that the operation of the system will be uninterrupted or error free. Hybrid Arts may from time to time, revise the performance of its system and in so doing, incur no obligation to furnish such revisions to you.

However, Hybrid Arts warrants the diskette(s) or cassettes on which the program is furnished and the hardware, to be free from defects in materials and workmanship under normal use for a period of ninety (90) days from the date of delivery to you as evidenced by a copy of your receipt.

LIMITATIONS OF REMEDIES

Hybrid Arts entire liability and your exclusive remedy shall be:

1. the replacement of any diskette, cassette or hardware not meeting Hybrid Arts "Limited Warranty" and which is returned to Hybrid Arts or an authorized dealer with a copy of your receipt,

or

2. if Hybrid Arts or the dealer is unable to deliver a replacement diskette, cassette or hardware which is free of defects in materials or workmanship, you may terminate this Agreement by returning the program and your money will be refunded.

IN NO EVENT WILL HYBRID ARTS BE LIABLE TO YOU FOR ANY DAMAGES, INCLUDING ANY LOST PROFITS, LOST SAVINGS OR OTHER INCIDENTAL OR CONSEQUENTIAL DAMAGES ARISING OUT OF THE USE OR INABILITY TO USE SUCH SYSTEM EVEN IF HYBRID ARTS OR AN AUTHORIZED DEALER HAS BEEN ADVISED OF THE POSSIBILITY OF SUCH DAMAGES, OR FOR ANY CLAIM BY ANY OTHER PARTY.

SOME STATES DO NOT ALLOW THE LIMITATION OR EXCLUSION OF LIABILITY FOR INCIDENTAL OR CONSEQUENTIAL DAMAGES SO THE ABOVE LIMITATION OR EXCLUSION MAY NOT APPLY TO YOU.

GENERAL

You may not sublicense, assign or transfer the license or the program except as expressly provided in this Agreement. Any attempt otherwise to sublicense, assign or transfer any of the rights, duties or obligations hereunder is void.

YOU ACKNOWLEDGE THAT YOU HAVE READ THIS AGREEMENT, UNDERSTAND IT AND AGREE TO BE BOUND BY ITS TERMS AND CONDITIONS. YOU FURTHER AGREE THAT IT IS THE COMPLETE AND EXCLUSIVE STATEMENT OF THE AGREEMENT BETWEEN US WHICH SUPERCEDES ANY PROPOSAL OR PRIOR AGREEMENT, ORAL OR WRITTEN, AND ANY OTHER COMMUNICATIONS BETWEEN US RELATING TO THE SUBJECT MATTER OF THIS AGREEMENT.



Hybrid Arts, Inc.TM

HYBRID RATE LICENSE AGREEMENT

THIS AGREEMENT is made this 1st day of January, 1998, between the undersigned Licensor and Licensee.

WHEREAS, the Licensor is the owner of the copyright in the software program known as "Hybrid Rate License Agreement";

AND WHEREAS, the Licensee desires to use the software program for the purpose of [illegible];

TERMS AND CONDITIONS

1. The Licensee shall pay to the Licensor a fee of [illegible] for the use of the software program.

2. The Licensee shall not copy, modify, or distribute the software program without the prior written consent of the Licensor.

3. The Licensee shall not use the software program for any purpose other than that specified in the license agreement.

4. The Licensee shall not use the software program in any way that would damage the reputation of the Licensor or its products.

5. The Licensee shall not use the software program in any way that would violate any applicable laws or regulations.

6. The Licensee shall not use the software program in any way that would constitute a breach of any applicable laws or regulations.

7. The Licensee shall not use the software program in any way that would constitute a breach of any applicable laws or regulations.

IN WITNESS WHEREOF, the Licensor and Licensee have hereunto set their hands and seals the day and date first above written.

Licensor

Licensee

[illegible]

[illegible]

[illegible]

[illegible]

[illegible]

[illegible]

[illegible]

MIDITRACK III™

**A MIDI Recorder, MIDI Synchronizer
and MIDI Remote Control System
for the ATARI 130XE Computer**

First Edition.

MidiTrack III program by Stefan Daystrom and Paul Rother.
MidiTrack III User Manual written by Pabini Gabriel-Petit.

 **Hybrid Arts, Inc.™**

A MIDI Recorder, MIDI Synchronizer and MIDI Remote Control System for the ATARI 130XE Computer

MidiTrack III program by Stefan Daystrom and Paul Rother.

MidiTrack III User Manual written by Pabini Gabriel-Petit.

Technical assistance from Bob Moore, Stefan Daystrom, Alan Hart and Jeff Fair.

Art Direction by Frank Foster.

Special thanks to Richard Petit, Charles Faris and Cathy Wyatt.

Laser typesetting by Smart Art Productions, Santa Monica, CA.

Printing by Haskell Printing, Santa Monica, CA.

©Copyright 1986 by Hybrid Arts Inc.

Appendix A and Glossary, ©Copyright 1986 by Pabini Gabriel-Petit and Hybrid Arts Inc.

MidiTrack II, MidiTrack III and MidiMate are trademarks of Hybrid Arts Inc.

ATARI 130XE is a trademark of ATARI Corporation.

DX7, RX11 and RX15 are trademarks of Yamaha International Corporation.

Drumulator is a trademark of E-mu Systems.

LinnDrum is a trademark of Linn Electronics.

Korg, Poly 61 and Poly 800 are registered trademarks of Keio Electronic Lab. Corp.

TR707 is a trademark of Roland Corporation.

Oberheim is a trademark of ECC Development Corporation.

If you have any questions, comments or corrections regarding MidiTrack III or its manual, or if there are any features that you would like to see incorporated in future software releases, we encourage you to write to Hybrid Arts, Inc., at:

11920 West Olympic Blvd., Los Angeles, CA 90064, USA
(213) 826-3777

Please fill out the registration card enclosed with your MidiTrack III system and return it to Hybrid Arts. This will give you access to our technical support staff and will enable us to keep you informed of any updates to your software or documentation, as well as new product releases.

Hybrid Arts' free Bulletin Board Service (BBS), a 300/1200/2400 baud system, is on line 24 hours a day, seven days a week. The service provides access to DX and CZ patches, songs, MIDI information and our suggestion box. Our BBS number is: (213) 826-4288.

The information in this user manual is subject to change without notice.

Table of Contents

Introduction.....	7
System Requirements.....	10
1 Getting Started.....	11
Setting Up.....	11
Start-Up Procedure.....	11
Entering Commands.....	12
2 Disk Operations	13
Disk Formatting.....	13
Backing up the Master Disk.....	13
Saving to Disk.....	14
Recalling from Disk.....	14
Disk Directory.....	15
Copying Songs.....	15
Multiple Disk Drive Access.....	15
Write-Protection.....	15
Disk Errors.....	16
Disk Handling.....	16
3 The MidiTrack Screen	19
Song Name.....	19
Revision Number.....	19
Tracks.....	19
Track Pointer.....	19
Track Name.....	19
Track On/Off: Solo & Mute.....	20
Track Activity Indicators:.....	21
The Jump Indicator.....	21
The Return Indicator.....	21
The Track End Indicator.....	21
The Change Indicator.....	21
The Note Activity Indicator.....	21
MIDI Channel Assignment Number.....	21
The Write-Protect Indicator.....	22
Percentage of Memory Used.....	23
Beats per Minute.....	23
Tempo Change Indicator.....	24
Step Value.....	24
Time Counter.....	24
Start Point.....	24
Song Position Pointer Indicator.....	24
Star Search Indicator.....	24
Punch-In Point.....	25
Punch-Out Point.....	25
End Point.....	25
Punch Track.....	25
MIDI Thru Channel.....	25
Instant Transposition.....	25
Sync Mode.....	26
Start/Stop Polarity Indicator.....	26
The Waiting Indicator.....	26
External Divider.....	26

The MidiTrack Screen (Cont.)

Metronome.....	26
Play/Record MIDI Functions.....	26
Remote Voice Patch Selection: MIDI Channel/Voice Patch/Limit.....	29
MIDI Record Channel.....	31
Memory Remaining Indicator.....	31
Drive Indicator.....	31
4 Playing and Recording Tracks	32
Play/Record Mode.....	32
Saving Tracks.....	32
Playback.....	33
5 Synchronization	34
Selecting the Sync Mode.....	34
Internal Sync.....	34
Programmable Tempo Changes.....	34
External Sync.....	35
The External Divider.....	35
Laying Down a Sync Track on Tape.....	36
Single-Step Mode.....	37
MIDI Clock Sync.....	38
Song Position Pointer and Star Search.....	39
Programming MIDI Start/Stop/Continue Commands.....	40
TTL Clock, Roland Sync Clock and Beat Sync.....	40
6 Editing	42
Copying a Track.....	42
Deleting a Track.....	42
Combining Tracks.....	42
Extracting Tracks.....	43
Transposition.....	43
Instant Transposition.....	44
Quantization.....	45
7 Auto-Location	47
Programming the Start Point.....	47
Programming the End Point.....	48
Using Auto-Location.....	49
8 Punch-In/Punch-Out Mode	50
Programming the Punch-In Point.....	50
Programming the Punch-Out Point.....	51
Implementing Punch-In/Punch-Out Mode.....	52
9 Step Edit Mode	54
10 Move (or "Copy and Paste")	56
Programming Digital Delay Effects.....	56
11 The Jump/Return Command Set	57
Simple Looping using the Jump Command.....	57
Using the Jump/Return Command Set.....	58
Playing Back a Song Incorporating a Jump/Return Command Set.....	60
Additional Jump/Return Features.....	61
Song Building using Jump/Return.....	61

12 Additional Editing Functions	63
Setting Overall Track Velocity.....	63
Programming Relative Velocity Changes.....	63
Setting an Overall Note Duration.....	64
Identifying "Hung" Notes.....	64
Editing "Hung" Notes.....	65
13 System Commands	67
Test Tones.....	67
MIDI Tune Request.....	67
MIDI Mode Selection.....	67
Additional MIDI Commands.....	68
Notes Display.....	69
Reset.....	69
Restoring Working Disk Parameters.....	69
14 Application Notes.....	71
Configuring A MIDI System.....	71
Using MIDI Drum Machines with MidiTrack III.....	72
Drum Machine Sync (For Non-MIDI Drum Machines).....	74
Tape Sync.....	74
Using 48 or 96 Clocks Per Beat	75
Using SMPTE Time Code.....	75
Automated Mixing Using MIDI Volume.....	76
APPENDIX A: Understanding the MIDI Specification	77
APPENDIX B: MidiTrack III Commands	79
APPENDIX C: Specification for Joystick Connection	84
APPENDIX D: The MidiTrack III Demonstration Songs	85
Glossary	87
Index	95

Introduction

Welcome to the world of professional MIDI recording and congratulations on your selection of Hybrid Arts' MidiTrack III system. Designed for the creative musician, MidiTrack III emulates the procedures used in professional multitrack tape recording, while providing many functions that can be implemented only through the manipulation of data by a computer. MidiTrack III is a powerful compositional tool.

While MidiTrack III provides many sophisticated features for the advanced user, every effort has been made to create a program that is "musician friendly" and to provide a manual that assumes no previous knowledge of MIDI sequencing. If in the course of reading this manual, you encounter computer terminology with which you are unfamiliar, please refer to the glossary provided at the end of the text.

The procedures for MidiTrack III's basic applications are easy to understand and follow. If you wish to immediately begin recording with MidiTrack III, follow the basic procedures set down in Chapter 4. This manual has been structured to allow you to use any function simply by referring to the relevant chapter, in which step-by-step procedures are presented. Most of MidiTrack III's features may be easily implemented by following the prompts that appear at the bottom of the MidiTrack Screen.

If you wish to take full advantage of MidiTrack III's many advanced features, we suggest a thorough perusal of this manual. The information provided here will be your guide as you venture into the exciting world of MIDI recording with MidiTrack III. You will soon discover many creative applications for MidiTrack III.

With MidiTrack III, you can record multitrack sequences in real time, save them to disk, then play them back in perfect sync, just as you would on a multitrack tape recorder. MidiTrack III provides 16 polyphonic tracks with a total capacity of up to 21,000 MIDI events. Any number of MidiTrack III systems may be linked to increase the number of available tracks and the MIDI event capacity. For example, linking two MidiTrack III systems would provide 32 tracks and 42,000 MIDI events.

MIDI has been adopted as a convention by the major synthesizer manufacturers to allow communication between their microprocessor-based devices and computers. For a complete explanation of MIDI (Musical Instrument Digital Interface) turn to Page 77, APPENDIX A: Understanding the MIDI Specification.

MidiTrack III is capable of recording the data for the full MIDI spec, including data for all of the 128 MIDI Controllers. Note duration and velocity information may be edited. Programmable velocity may be used to emulate automated mixing. Every nuance of dynamic change may be programmed for each individual instrument. MIDI volume may be used to automate the relative levels of the various instruments in the mix.

MidiTrack III permits all MIDI Controller data to be filtered on input or output; that is, the recording of data for all MIDI Controllers may be prevented on input, or MIDI Controller data may be globally removed from a MidiTrack song on playback.

MidiTrack III allows you to name your songs and tracks. In MidiTrack III, overdubs may be recorded on new tracks while listening to the playback of all previously recorded tracks, or while listening to selected tracks, through the use of the Solo and Mute functions.

MidiTrack III's Step Edit Mode allows you to enter song data or edit a track one step at a time. Each step may be designated as a single clock pulse (with 24 clocks per quarter note), a quarter note, or a step of any user-defined duration. The Solo and Mute functions may be used even in the Step Edit Mode to make listening for hard-to-pinpoint mistakes easier. To permit you to instantly A/B various combinations of tracks, three Memory Registers are provided for Track Mute Presets.

With MidiTrack III, it is possible to repeat a section of a track or chain tracks, without using additional memory, by using MidiTrack III's powerful Jump/Return Command Set. A Jump Command may be located at any point, on any track, causing playback to Jump to the beginning of a user-designated destination track, and to continue on that track until a Return Command is encountered, effectively chaining tracks together. Full editing capabilities may be implemented in the sections of a song affected by Jump/Return Command Sets.

MidiTrack III permits automated Punch-In/Punch-Out editing on any selected track, enabling you to correct mistakes without having to record the entire track again. When overdubbing, step editing or punching in/out, auto-location to a user-designated Start Point, or cue, within the song, and playback to a user-designated End Point may be implemented.

A MidiTrack III feature called Move allows you to "copy and paste" sections of a track, which simplifies the process of sequencing a song which has sections that are repeated. This feature may even be used to program digital delay effects. The song data on any track, or section of a track, can be copied, delayed by a user-programmable interval and velocity adjusted, then recombined with the song data on the original track.

Transposition of individual tracks by half-steps, up or down, is provided over a range of five octaves. Instant Transposition permits the simultaneous transposition of all of the 16 tracks over a range of one octave.

MidiTrack III provides Memory-protection for each track to prevent the accidental erasure of your work. With MidiTrack III, any number of tracks may be Combined, or merged. If the result is not to your liking, use the Extract command to restore combined tracks to user-designated track locations. When tracks are merged, the MIDI Channel Assignments for the original tracks are preserved. The merged track may be set to playback on one MIDI channel or on all MIDI channels.

In MidiTrack III, all editing is non-destructive. Edits are created in an edit buffer, then saved to a user-designated track. If you choose to save your edits to the source track, the original version will be overwritten, or you may designate a different destination track, in order to preserve the original version. After a track has been recorded, Quantization, or auto-correction, may be implemented. Quantization may be set to any of 120 different clock values. The quantized version of the track may be saved to the source track or to a different destination track, if you wish to preserve the original version. When Quantization is implemented, the duration of the note remains unchanged.

Programmed variations in tempo within a song affect all clock outputs. Tempo may be adjusted in real time over a range of from two to 750 Beats Per Minute (BPM). Programmable playback Tempos may be stored in three Memory Registers.

MidiTrack III provides several Sync Mode options, including: Sync to Tape; MIDI Clock Sync; Internal Sync, in which the MidiTrack III system provides the master clock; and External Sync, to a non-MIDI drum machine, sequencer, SMPTE code or audio trigger, using a user-specified standard clock. MidiTrack III simultaneously outputs the following synchronization codes: MIDI Clock, with Song Position Pointer (SPP), which communicates the exact point in a MIDI song at which a slave MIDI device, such as a drum machine or sequencer, is to start or stop; TTL (Transistor Transistor Logic) Clock, a universal clock output, standard for microprocessor-based devices; Roland Sync Clock; Beat Sync, which outputs one pulse per metronome beat; and an audio click. The MidiMate Interface provides Sync In and Out jacks (1/4" phone jacks).

MidiTrack III's remote control features include: MIDI Thru Mode, with MIDI Channel Assignment, which permits MIDI data generated by a master controller keyboard to be sent on any channel, via MidiMate's MIDI OUT port, to a synthesizer set to receive on that channel, providing audio output; patch selection from the computer or master controller keyboard; and selection of MIDI Mode (Poly/Omni/Mono) and Tune Request from the computer.

Disk utilities supported by MidiTrack III include formatting blank disks and copying songs. Only one song may be saved on each side of a disk.

MidiTrack II song files are upwardly compatible with MidiTrack III. If you have been using Hybrid Arts' MidiTrack II software, but have now upgraded your system to MidiTrack III, your MidiTrack II song files may be updated, using the additional capacity and features of MidiTrack III. MidiTrack III song files may not be saved to a disk formatted using MidiTrack II.

SYSTEM REQUIREMENTS:

The MidiTrack III system includes the MidiTrack III Master Disk, the MidiMate Interface and two MIDI cables.

1. The MidiTrack III system has been designed for the Atari 130XE personal computer, which provides 128k of RAM.
2. Any Atari-compatible disk drive, such as the Atari 1050 or Atari 810, may be used to store data on single-sided, single-density, 5 1/4"-mini floppy disks.
3. A color or black-&-white monitor, or a TV set.
4. One or more MIDI-equipped synthesizers.
5. An audio playback system.

1. GETTING STARTED

SETTING UP

1. Make sure the Atari 130XE, disk drive(s) and monitor are properly installed.
2. With the power off, plug the I/O cable attached to the MidiMate Interface into whichever I/O serial port on your disk drive is free; that is, not being used to connect the disk drive to the computer.
3. Verify that your synthesizer and audio playback system are properly connected.
4. Use one of the MIDI cables included with your MidiTrack III system to connect the MIDI OUT jack on the MidiMate Interface to the MIDI In jack on your synthesizer, and the other to connect the MIDI Out jack on your synthesizer to the MIDI IN jack on the MidiMate Interface.

If you wish to incorporate more than one synthesizer in your MIDI system, refer to Application Notes, Page 71, where several configurations for interconnecting MIDI-equipped devices are illustrated. In the Application Notes, you will also find descriptions of various methods for using the SYNC IN and SYNC OUT jacks on the MidiMate Interface in conjunction with drum machines and tape recorders.

START-UP PROCEDURE

To boot your MidiTrack III Master Disk, turn on your disk drive, then wait for its busy light to go off. Insert the MidiTrack III Master Disk, label up, and close the disk drive door. Make sure that there is no cartridge in the cartridge slot. Turn on your computer and the disk drive will run. Wait while the system loads. When MidiTrack III has been successfully loaded, you will briefly see Hybrid Arts' copyright notice and version date on your monitor's screen, followed by four audible test tones from your synthesizer, to indicate that your synthesizer is, indeed, properly connected; then, the MidiTrack Screen will appear.

If no synth tones are heard, make sure that the MidiMate Interface is properly connected to the disk drive port, that the MIDI cables are connected as described above, that your audio playback system is properly connected, and that the volume is turned up on your synthesizer, as well as on your audio system.



It is also possible that your synthesizer may be assigned to a different MIDI Channel than that on which the tones are being transmitted, usually MIDI Channel 1. Verify that your synth is assigned to MIDI Channel 1. If, after checking all of the above, you still do not hear any test tones, while holding down the SHIFT key, hit I (SHIFT + I) to send the test tones on all channels, one after another.

If the MidiMate ERROR message appears on the screen, the MidiMate Interface is not properly connected to the disk drive serial port. If, after checking the connection, the error message persists, connect the MidiMate Interface directly to the Atari 130XE, to verify that the MidiMate Interface is working properly.

ENTERING COMMANDS

Whenever you are instructed to enter a multiple-key command, such as SHIFT + I, while holding the first one or two keys down, hit the last key in the command.

All prompts appear at the bottom of the MidiTrack Screen and require that you enter your response, then hit the Return key.

When entering any parameter, complete your input by hitting the Return key.

2. DISK OPERATIONS

Note: No Disk Operating System (DOS), other than that which is integral to the MidiTrack system, is necessary.

DISK FORMATTING

All new disks must be formatted before they can be used to save song files. This procedure establishes the layout of track sectors on the disk.

WARNING: When a disk is formatted, any data already stored on the disk will be erased.



To initiate the formatting procedure, while holding down the SHIFT and CONTROL keys, hit the comma key (,) (**SHIFT + CONTROL + ,**). You will be prompted to insert a new disk into the disk drive. To format the disk, hit the Return key. When the disk has been formatted, the MidiTrack Screen will reappear.

BACKING UP THE MASTER DISK TO WORKING DISKS

It is very important that you create backup copies of your MidiTrack III Master Disk to serve as your working disks. After making several working disks, store the write-protected Master Disk in a safe place. Always use your working disks to boot the MidiTrack III system.



The Master Disk copying procedure is initiated from the MidiTrack Screen. To copy the MidiTrack III Master Disk, while holding down the SHIFT and CONTROL keys, hit N (**SHIFT + CONTROL + N**). Insert a formatted disk into the disk drive, then hit the Return key. When the MidiTrack III software has been copied to the disk, the MidiTrack Screen will reappear.

Additional working disks may be made from these working disks, using the same command as above. The BPM/Tempo Preset Registers, Track Mute Preset Registers, Sync Mode and External Divider, and the MIDI Thru Channel will be transferred to the new working disk. When you boot up the new working disk, the BPM (Beats Per Minute) will be set as in Tempo Register 8, and the Track Mutes, as in Track Mute Register 5.

To verify that a good copy has been made, with the disk still in the drive, turn the power of the Atari 130XE off, then on again, to boot MidiTrack III from your new working disk.

SAVING TO DISK



It is advisable to periodically save your work to disk to prevent its loss in the event of even a momentary power failure. After completing a song or a session, your work must be saved to disk.

Insert a formatted disk into your disk drive. To Save your song to disk, while holding down CONTROL and SHIFT, hit F (**CONTROL + SHIFT + F**). A prompt to "Save as #" and a Disk Directory will be displayed. Only one song may be stored on each side of a disk. A song file of 21,000 MIDI events, along with the MidiTrack III program, occupy all of the available memory on one side of a disk. In order to allow revisions and additions to existing song files, it was deemed best to implement song files having the maximum capacity. Therefore, enter the Song Number 1 at the prompt "Save as #."

WARNING: Saving a song to disk will erase any song data already stored on the disk.



If the disk is already full and you do not wish to write over its contents, or if you should decide not to save the song for any other reason, hit the ESC (**Escape**) key.

To complete the Save procedure, hit the Return key. Your song will now be saved to disk.

To make a backup copy of your song, repeat the Save procedure using a different disk. When you revise the song, Save the revised version to both disks.

RECALLING FROM DISK



WARNING: Before recalling a song from disk, Save the song currently resident in the computer's internal memory or RAM (Random Access Memory) to disk.

To Recall a song from disk, while holding down CONTROL and SHIFT, hit G (**CONTROL + SHIFT + G**). A prompt to "Recall #" and a Disk Directory will be displayed. Enter the Song Number 1 at the prompt, followed by Return. Your song will be recalled from disk.

MidiTrack II songs may be recalled from MidiTrack III. MidiTrack II, which is capable of saving only 7,000 MIDI events, permits up to three songs to be saved per disk side. To recall a MidiTrack II song, enter the appropriate Song Number (1,2 or 3) at the "Recall #" prompt, followed by Return.

DISK DIRECTORY

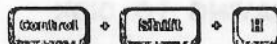

To see the Disk Directory of any working disk, while holding down CONTROL and SHIFT, hit H (**CONTROL + SHIFT + H**), and the Disk Directory will appear at the bottom of the screen. The Disk Directory lists the Song Number, followed by the Song Name and the Revision Number, which is incremented each time a song is saved to disk. Hit "any key to return" to Record/Play Mode.

COPYING SONGS

It is advisable to make backup copies of your songs.

WARNING: Save the song currently resident in RAM (Random Access Memory) to disk before recalling the song to be copied.



The song to be copied must first be recalled from disk. Once the song has been loaded into memory (RAM), to Copy the song to a blank formatted disk, while holding down CONTROL and SHIFT, hit F (**CONTROL + SHIFT + F**). At the "Save as #" prompt, enter the Song Number 1, followed by Return.

Note: The MidiTrack III program and your song occupy different parts of the disk. A complete working disk, including the MidiTrack III program and a song, may be saved.

MULTIPLE DISK DRIVE ACCESS

MidiTrack III allows access to as many as four disk drives for saving and recalling songs, formatting disks and copying working disks.



To increment the drive number, while holding down SHIFT, hit the period key <.> (**SHIFT + .**).



To decrement the drive number, while holding down SHIFT, hit the comma key <,> (**SHIFT + ,**).

The default is Drive 1. Once the number of an alternate drive has been selected, the Drive indicator "Drive=" will appear at the bottom right-hand corner of the MidiTrack Screen.

WRITE-PROTECTION

To prevent the accidental erasure of your songs, it is recommended that you apply write-protect tabs to your song disks.

Before attempting a save procedure to a write-protected disk, it is necessary to remove the write-protect tab.

DISK ERRORS

The most common causes of disk errors are:

1. Forgetting to insert a disk in the drive.
2. Inserting the disk improperly; that is, with the label side down.
3. Writing to a write-protected disk.
4. Faulty disk media.

Should you encounter a DISK ERROR message:

1. To abort the procedure and return to the MidiTrack Screen, hit the ESC (Escape) key.



2. To try the procedure Again, while holding down SHIFT, hit A (SHIFT + A).

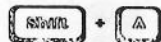

3. To Continue, ignoring the disk error message, while holding down SHIFT, hit C (SHIFT + C). If the Disk Error message has appeared because you have failed to properly insert a disk in the drive or because the disk is write-protected, you may correct the problem and Continue.



WARNING: Continuing after a Disk Error message occurring for any other than the above-mentioned reason will result in bad data.

Note: If you suspect that a disk is faulty, save the song onto another formatted disk. Verify that the save procedure was successful. Then attempt to reformat the faulty disk or simply discard it.

DISK HANDLING

To avoid damaging your MidiTrack III Master Disk and working disks, handle them with care. Never touch the exposed area of the disk. Always keep the disks in their protective sleeves when they are not being used. Avoid placing disks near magnetic fields, such as those present in loudspeakers, or exposing them to dust, liquids, or extreme hot or cold.

Always label your disks.

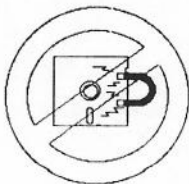

Keep Away From
Magnetic Fields

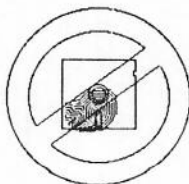

Never Touch Exposed Media

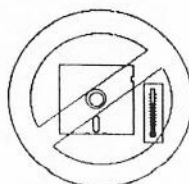

10 - 52° C
(50 - 125° F)

MIDITRACK III (C) 1985 by Hybrid Arts

			001
→ 01	↑	00%	BPM= 120 06
02	↑	00%	T=0000.00
03	↑	00%	ST= 0000.00
04	↑	00%	PI= 0000.00
05	↑	00%	PO= 0000.00
06	↑	00%	EN= 0000.00
07	↑	00%	Ptr= 1
08	↑	00%	Thru= 1 IT= +0 1
09	↑	00%	
10	↑	00%	Sync=Int stop
11	↑	00%	edv=01
12	↑	00%	Met=vc
13	↑	00%	P/R= vpcs / vpcs
14	↑	00%	CPL=1 001/064
15	↑	00%	Rch=
16	↑	00%	Mem=100%

The MidTrack Screen

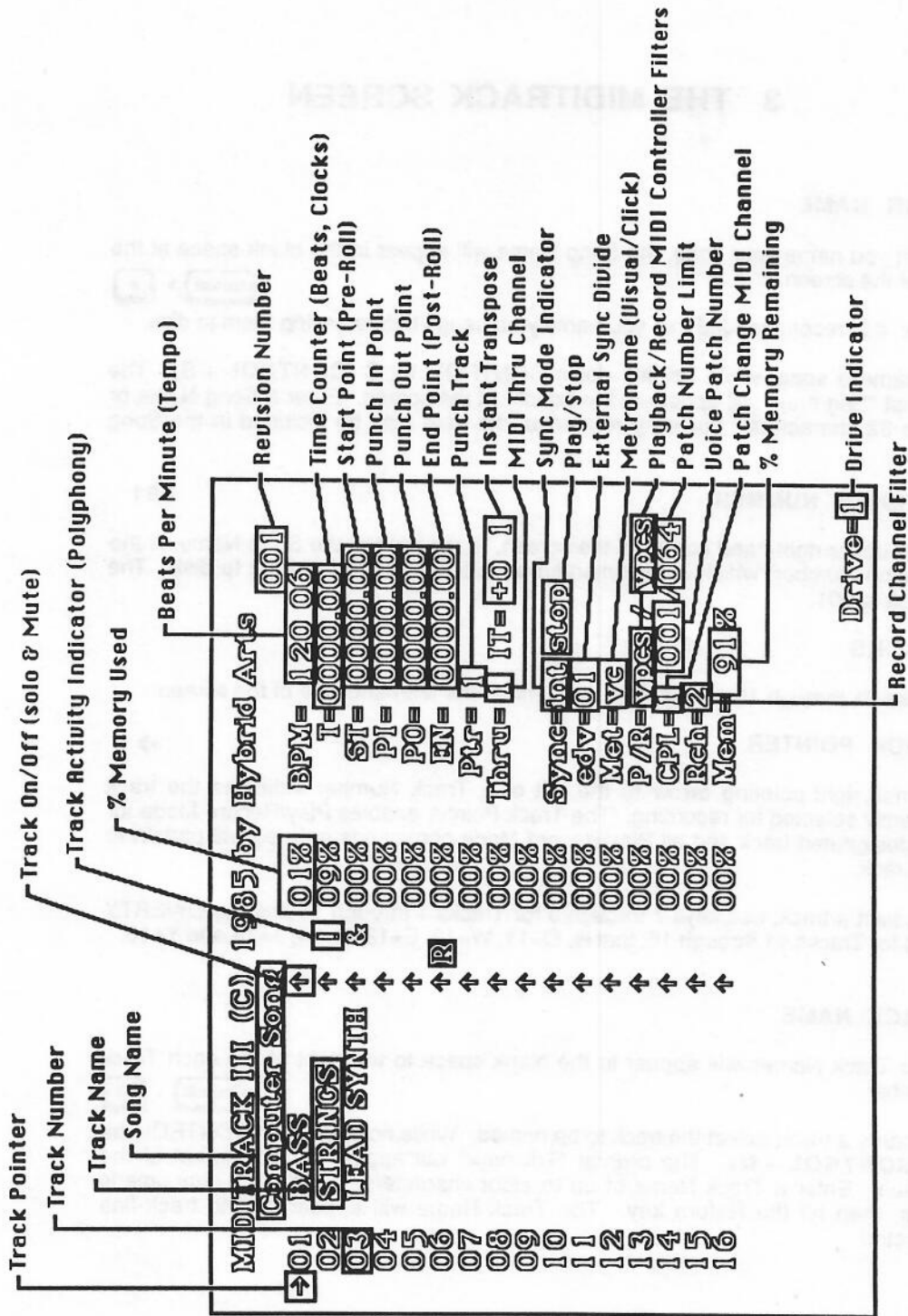

The Miditrack Screen

3 THE MIDITRACK SCREEN

SONG NAME

When you name your song, the Song Name will appear in the blank space at the top of the screen.



Note: It is recommended that you name your songs before saving them to disk.

To name a song, while holding down CONTROL, hit S (**CONTROL + S**). The prompt "Sng nm=" will appear at the bottom of the screen. Enter a Song Name of up to 32 characters. For easy reference, the date may be included in the Song Name.

REVISION NUMBER

001

In the upper right-hand corner of the screen, to the right of the Song Name, is the Revision Number, which is incremented each time a song is saved to disk. The default is 001.

TRACKS

Tracks 01 through 16 are listed in a column at the left-hand side of the screen.

TRACK POINTER



A small right-pointing arrow to the left of a Track Number indicates the track currently selected for recording. The Track Pointer enables Play/Record Mode for the designated track and all Play/Record Mode commands entered will pertain to this track.

To select a track, use keys 1 through 0 for Tracks 1 through 10 and the QWERTY keys for Tracks 11 through 16; that is, Q=11, W=12, E=13, R=14, T=15 and Y=16.

TRACK NAME

Your Track Names will appear in the blank space to the right of the each Track Number.

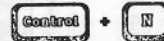

To name a track, select the track to be named. While holding down CONTROL, hit N (**CONTROL + N**). The prompt "Trk nm=" will appear at the bottom of the screen. Enter a Track Name of up to eight characters, using the alphanumeric keys, then hit the Return key. The Track Name will appear on the track line selected.

TRACK ON/OFF: SOLO & MUTE

**

On each track line, to the right of the Track Name, is a small up- or down-pointing arrow. An up arrow indicates that the track is On; a down arrow, that the track is Off or Muted. During record or playback, tracks may be turned On or Off in any combination.



After selecting a track, to turn On the audio output for that track, hit the UP ARROW key on the computer keyboard.



To Mute or turn Off the audio output for a selected track, hit the DOWN ARROW key.

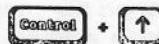

To turn On all 16 tracks simultaneously, while holding down CONTROL, hit UP ARROW (**CONTROL + UP ARROW**).

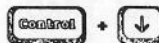

To turn Off all 16 tracks simultaneously, while holding down CONTROL, hit DOWN ARROW (**CONTROL + DOWN ARROW**).



To Solo a selected track, while holding down SHIFT, hit UP ARROW (**SHIFT + UP ARROW**). Only the selected track will be heard.



To Solo or listen to each individual track in succession, while holding down CONTROL and SHIFT, hit DOWN ARROW (**CONTROL + SHIFT + DOWN ARROW**). The Track Pointer will move down to the next track, which will immediately begin to play. To continue to Solo successive tracks, repeatedly enter the above command. If, after listening to Track 16, the command is entered again, the track pointer will wrap around to Track 1. To Solo successive tracks in the opposite direction, while holding down CONTROL and SHIFT, hit UP ARROW (**CONTROL + SHIFT + UP ARROW**).



Three Memory Registers are provided for Track Mute Presets, which may be used to Save and Recall the On/Off status for each track.

To Save the current On/Off status for all tracks to Memory Register 5, while holding down CONTROL, hit 5 (**CONTROL + 5**); to Memory Register 6, CONTROL + 6; or to Memory Register 7, CONTROL + 7.

To Recall a Track Mute Preset from Memory Register 5, while holding down SHIFT, hit 5 (**SHIFT + 5**); from Memory Register 6, SHIFT + 6; from Memory Register 7, SHIFT + 7.

TRACK ACTIVITY INDICATORS:

THE JUMP INDICATOR

J

When the song is advanced to the exact location (beat and clock) where a Jump command has been entered on a track, an inverse video J will appear on the track line in the Track Activity Column. To use the Jump/Return Command Set, see Page 57.

THE RETURN INDICATOR

R

When the song is advanced to the exact location where a Return command has been entered on a track, an inverse video R will appear on the track line in the Track Activity Column. To use the Jump/Return Command Set, see Page 58.

THE TRACK END INDICATOR

E

When playback has advanced past the data recorded on a given track, an inverse video E will appear on the track line in the Track Activity column.

THE NOTE ACTIVITY INDICATOR

The Note Activity indicator will appear on each track line, in the Track Activity Column, which is located to the right of the Track On/Off indicators. The Note Activity indicator represents the polyphony, or number of notes played simultaneously, on that track. The symbols which correspond to the numeric keys (when in Shift Mode) are used to indicate the polyphony: 1=!, 2=", 3=#, 4=\$, 5=%, 6=&, 7=' , 8=@ and 9=(.

THE CHANGE INDICATOR

c

If any Changes (c) have been made on a track since the last time the song was saved to disk or recalled from disk, the c indicator will appear on the track line, to the right of the Track On/Off indicator, to remind you to save the revised song to disk before ending the session.

MIDI CHANNEL ASSIGNMENT NUMBER

With MidiTrack III, a track may be assigned to any of the 16 MIDI Channels. When using MidiTrack III to record or playback songs, in order to send MIDI data from a selected track to a specific synthesizer, the MIDI Channel Assignment of that track should correspond to the MIDI Channel Assignment of the synthesizer. More than one track may be assigned to the same MIDI Channel. MIDI Channel Assignments may be changed in real time.

If no MIDI Channel has been assigned to a track, on playback, the MIDI data on that track will be sent on the output MIDI Channel active on the synthesizer when the track was recorded. The MIDI Channel for a selected track may be reassigned on playback, causing the new Channel Assignment to override the recorded Channel Assignment.

When a MIDI Channel has been assigned to a track, the MIDI Channel Assignment Number will appear on the track line, to the right of the Track On/Off indicator.

To set the MIDI Channel Assignment for a selected track, while holding down CONTROL and SHIFT, enter the Channel Number (**CONTROL + SHIFT + Channel Number**). MIDI Channel Numbers are designated as follows: keys 1 through 0 correspond to MIDI Channels 1 through 10, and the QWERTY keys to MIDI Channels 11 through 16; that is, Q=11, W=12, E=13, R=14, T=15 and Y=16.

The MIDI Channel Assignment for a selected track may be defeated by holding down CONTROL and SHIFT, and hitting U (**CONTROL + SHIFT + U**). If the MIDI Channel has been reassigned on playback, this command will cause the MIDI Channel Assignment to default to that active when the track was recorded.

In order for the current MIDI Channel Assignment of a source track to be recorded onto a destination track with the MIDI song data, it is first necessary to record the MIDI Channel Assignment on the source track.

The MIDI Channel Assignment of a track will be recorded as a side effect of most editing procedures involving the "From tr#" and "To tr#" prompts, with the exception of the Copy and Move procedures.

If the MIDI Channel Assignment for a track has not been previously recorded, one of two methods may be used to record a track's MIDI Channel Assignment:

- 1) Combine an individual track with itself.
- 2) Transpose a track, assigning the value 0 (zero) for the transposition.

THE WRITE-PROTECT INDICATOR

p

When a track has been Write-Protected, the p indicator will appear on the track line, to the right of the MIDI Channel Assignment Number. A write-protected track may not be altered. When you have completed a good take, the track on which it is recorded should be write-protected to prevent the accidental erasure of your work.



To Write-Protect a selected track, while holding down CONTROL, hit P (**CONTROL + P**).



If you wish to revise a write-protected track, you may cancel the write-protection on a selected track, by holding down CONTROL and SHIFT, then hitting P (**CONTROL + SHIFT + P**).

PERCENTAGE OF MEMORY USED

00%

In a column at the center of the screen, the percentage of memory used represents the portion of the total memory available for the song which has been used by each track. The percentage for each track is rounded off. Therefore, the total may slightly exceed 100%.

BEATS PER MINUTE

BPM= 160

The Beats per Minute (BPM) setting is indicated at the top of the column on the right-hand side of the screen. In Internal Sync, MidiTrack III provides the master clock, which is governed by the BPM setting. The tempo is established by the BPM setting. Tempo may be accurately adjusted in real time over a range of from two to 750 BPM. Each beat is equivalent to a quarter note. MidiTrack III has a resolution of 24 clocks per beat; that is, a beat is divided into 24 clocks. A clock is the smallest unit of time implemented in MidiTrack III. BPM is displayed in beats and clocks. At 120 BPM, there are two beats, or 48 clocks, per second. Thus, at 120 BPM, MidiTrack III is accurate to 1/48th of a second.



To increment BPM, use the > (greater than) key. To increase BPM in increments of ten, while holding down SHIFT, hit > (**SHIFT + >**).



To decrement BPM, use the < (less than) key. To decrement BPM by ten, while holding down SHIFT, hit < (**SHIFT + <**).



To enter BPM using the numeric keys of the computer, while holding down CONTROL, hit B (**CONTROL + B**). The prompt "BPM=" will appear at the bottom of the screen. Enter the number of BPM, followed by Return. Should you decide not to change the BPM, hit the ESC (Escape) key.

Three Memory Registers are provided for BPM/Tempo presets. When the MidiTrack III system is booted, the Tempo Registers hold the following preset values: Tempo Register 8, 120 BPM; Tempo Register 9, 160 BPM; and Tempo Register 10, 240 BPM.

To save a tempo to a Tempo Register, set BPM, following the procedures outlined above, then while holding down CONTROL, hit 8, 9, or 0, (**CONTROL + 8**) (**CONTROL + 9**) (**CONTROL + 0**), to save the current BPM setting to Tempo Register 8, 9, or 0, respectively.

To recall a tempo from a Tempo Register, while holding down SHIFT, hit 8, 9, or 0, (**SHIFT + 8**) (**SHIFT + 9**) (**SHIFT + 10**), to recall Tempo Register 8, 9 or 0, respectively.

TEMPO CHANGE INDICATOR

t

When playback has advanced to the exact location of a programmed Tempo Change, the t indicator will appear in the Beats per Minute display (BPM=), in the space just to the right of the equal sign.

STEP VALUE

06

A programmable Step Value, entered in clocks, is displayed just to the right of the BPM setting. The default for this Step Value is 06; that is, 6 clocks, or a sixteenth note.

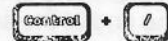

To set the Step Value, while holding down CONTROL, hit the / key (CONTROL + /). The prompt "V step=" will appear at the bottom of the screen. Enter the Step Value in clocks, which may be any number between 1 and 96, and hit RETURN.

To use Single Step Mode, refer to Page 54.

TIME COUNTER

T=0000.00

The Time Counter displays the current location in the song. The four digits to the left of the decimal point count the number of beats from the beginning of the song. The two digits to the right of the decimal point count the number of clocks which have elapsed in the current beat. At BPM settings of 16 or less, the Time Counter will display both beats and clocks. At BPM settings of 17 or greater, the Time Counter will display beats only. In the Step Editing Mode, both beats and clocks are displayed.

START POINT

ST=0000.00

The Start Point for playback, or cue, may be set at any point between the beginning and end of the song. To set the Start Point, refer to Page 47.

SONG POSITION POINTER INDICATOR

⇒

When Song Position Pointer (SPP) is enabled, a right-pointing arrow replaces the equal sign (=) in the Start Point Indicator (ST=0000.00). To use Song Position Pointer, refer to Page 38.

STAR SEARCH INDICATOR

*

Star Search causes MidiTrack to send a MIDI Clock signal before the Start Point has been reached, permitting MidiTrack and another MIDI device to lock in sync and start their playback simultaneously.

When Star Search is enabled, an asterisk (*) appears in the Start Point Indicator (ST=0000.00) to replace the equal sign (=) in the Start Point Indicator. To Use Star Search, refer to Page 38.

PUNCH-IN POINT

PI=0000.00

Punch-In/Punch Out editing permits you to correct mistakes, overwriting the original version, or to insert new musical passages at any point, on any track. To set the Punch-In Point, refer to Page 50.

PUNCH-OUT POINT

PO=0000.00

To set the Punch-Out Point, refer to Page 51.

END POINT

EN=0000.00

The End Point may be set at any point after the Start Point to stop playback before the end of the song. To set the End Point, refer to Page 48.

PUNCH TRACK

Ptr=00

The track on which Punch-In/Punch Out editing is to be implemented is called the Punch Track. To set the Punch Track, refer to Page 52.

MIDI THRU CHANNEL

Thru=

When MidiTrack III's MIDI Thru Mode is enabled, MIDI data output by a master controller keyboard, received at MidiMate's MIDI IN port, can be sent, via MidiMate's MIDI OUT port, on any user-designated MIDI Channel, thus providing audio output from the synthesizer set to receive on the same MIDI Channel. This feature allows you to input your song data from the master controller keyboard of your choice, while hearing the output from any synthesizer selected.

When the MIDI Thru Channel display (Thru=) is blank, the MIDI Thru Mode is disabled.



To increment the MIDI Thru Channel, while holding down CONTROL, hit J (CONTROL + J).



To decrement the MIDI Thru Channel, while holding down CONTROL, hit H (CONTROL + H).

INSTANT TRANSPOSITION

IT=+0 2

The Instant Transposition (IT=+0 2) is displayed on the MidiTrack Screen just to the right of the MIDI Thru Channel (Thru=) and indicates the Transposition Value to be used, in a positive number of between +0 and +7 half-steps or a negative number of between -1 and -8 half-steps, followed by the number of the MIDI Channel upon which Instant Transposition is to have no effect.

Instant Transposition permits the simultaneous transposition of all sixteen tracks over a range of more than one octave. To use Instant Transposition, refer to Page 44.

SYNC MODE

Sync=int stop

MidiTrack III is capable of operating in five different Sync Modes (Sync=): Internal (int), External (ext), Single Step (sst), MIDI and TTL Clock (joy). The Sync status will be indicated as either Play or Stop. For more information about Synchronization, refer to Page 34.

START/STOP POLARITY INDICATOR

=

When the Start on high/Stop on low polarity has been selected, an equal sign (=) will be seen in the Sync= display. When Start on low/Stop on high has been selected, the equal sign (=) in the Sync= display will appear in inverse video.

THE WAITING INDICATOR

w

After the song has been cued to the Start Point, the w indicator will appear to indicate that MidiTrack is waiting for a command to begin playback.

EXTERNAL DIVIDER

edv=01

When using External Sync, by setting the External Divider, it is possible to accommodate all of the common clock standards. To use the External Divider, refer to Page 36.

METRONOME



Met=

The Metronome provides a flashing-screen visual indicator and an audio click to mark each beat. To activate the Metronome in real time, hit M. The visual metronome (Met=v), the audio click (Met=c), both or neither may be selected by consecutive hits of the M key.

PLAY/RECORD MIDI FUNCTIONS

P/R=vpcs/vpcs

By entering the Play/Record MIDI Functions (P/R=vpcs/vpcs), the recording of MIDI Function data and the playback of previously recorded MIDI Function data may be enabled or disabled. These MIDI Functions may be selected individually or in combination. Only those MIDI Functions selected by the user will be enabled. Each MIDI Function must be implemented separately for Playback and/or Record. The following MIDI Functions may be enabled for Playback (P) and/or Record (R): Voice Patch Change (v), Pitch-Bend (p), MIDI Controllers (c), and Start/Stop/Continue Commands (s). In Record MIDI Functions, After-Touch data is not included in the MIDI Controllers data. Record After-Touch must be enabled separately (See Page 29). When Record Aftertouch has been enabled, the letter a will appear at the far right of the Play/Record MIDI Functions display.

For example: In the Record Mode, with Voice Patch Change enabled, all voice patch changes made in the course of recording your song will be recorded. Then, with Voice Patch Change enabled for Playback Mode, as the song is played back, Voice Patch Changes will be implemented on your synthesizer at precisely the points in the track where they were entered in Record Mode.

MidiTrack III saves only changes of the Voice Patch. When entering a song in real time, the number of the Voice Patch which is active when you begin playing will not be recorded. To circumvent this omission, enter the Voice Patch to be selected at the beginning of the track from Step Edit Mode. Refer to Page 30 for this procedure. If you wish, a separate track may be used to record just the Voice Patch Changes, which may be entered in Step Edit Mode. The Voice Patch Change track may then be Combined, or merged, with the music track.

Note: Refer to your synthesizer's manual to determine the proper way to implement its MIDI Program Change capability.

MidiTrack III permits any of the 128 MIDI Controllers, including the Modulation Wheel, Breath Controller, Sustain Pedal, After-Touch and MIDI Volume, to be recorded. For playback, all of the Play MIDI Controllers may be either enabled or disabled as a group. When recording, Record MIDI Controllers may be enabled to record the data for all MIDI Controllers, with the exception of After-Touch data (see above).

Note: The Yamaha DX7 sends After-Touch data constantly. The sending of After-Touch information can not be disabled on the synth. Since After-Touch data devours tremendous quantities of sequencer memory, it is advisable to filter out any unwanted After-Touch data, by disabling After-Touch in the Record Mode (See Page 29. The Korg Poly 61 and Poly 800 send a constant stream of Modulation data. It is advisable to implement filtering of MIDI Controller data in the Record Mode.

MidiTrack III transmits and responds to MIDI Start/Stop/Continue Commands. With the Play MIDI Functions MIDI Start/Stop/Continue Commands implemented in any Sync Mode, MidiTrack will transmit Start/Stop/Continue Commands, as well as a MIDI Clock output, to another MIDI device via MidiMate's MIDI OUT port. With the Record MIDI Functions MIDI Start/Stop/Continue Commands implemented in any Sync Mode, MidiTrack songs may be started, stopped and caused to continue by an external MIDI device via MidiMate's MIDI IN port.

Note: Refer to the manual for your MIDI sequencer or drum machine to determine whether or not the device is capable of transmitting and receiving MIDI Start/Stop/Continue Commands, and, if it has this capability, how it may be implemented.

The following procedure allows you to select which MIDI Function data sent by your synthesizer will be received as Record input by MidiTrack III and which will be filtered out:



While holding down CONTROL, consecutive hits of the F key (**CONTROL + F**) will cause the display to step through the 16 possible combinations of Record MIDI Functions, ranging from all Functions off to all Functions on; or hold down CONTROL and the F key to cycle rapidly through the options, until the desired combination is displayed.



Use the following procedure to select which MIDI Function data recorded by MidiTrack III will be sent to your synthesizer on Playback and which will be filtered out:



While holding down CONTROL, consecutive hits of the G key (**CONTROL + G**) will cause the display to step through the 16 possible combinations of Play MIDI Functions; or hold down CONTROL and the G key to cycle rapidly through the options, until the desired combination is displayed.

The following table illustrates all of the possible combinations of Play/Record MIDI Functions and the procedure used to select the MIDI Functions to be enabled or disabled:

P/R=

Function	PLAY				RECORD				Function	
	Voice	Pitch Bend	MIDI Controller	Start/Stop	Voice	Pitch Bend	MIDI Controller	Start/Stop		
Enter with CONTROL+F Hold CONTROL and hit F repeatedly to step through all 16 combinations 				1					Enter with CONTROL+G Hold CONTROL and hit G repeatedly to step through all 16 combinations 	
	v			2	v					
		p		3		p				
	v	p		4	v	p				
			c	5			c			
	v		c	6	v		c			
		p	c	7		p	c			
	v	p	c	8	v	p	c			
				s	9			s		
	v			s	10	v		s		
		p		s	11		p	s		
	v	p		s	12	v	p	s		
			c	s	13			c		s
	v		c	s	14	v		c		s
		p	c	s	15		p	c		s
	v	p	c	s	16	v	p	c		s

The recording of After-Touch data may be enabled or disabled; that is, toggled on and off. In the default status, After-Touch data will be filtered from the recording of MIDI data. Before the recording of After-Touch data may be enabled, it is first necessary to enable Record MIDI Controllers (c) (See Page 28). To enable Record After-Touch, while holding down SHIFT, hit Y (**SHIFT + Y**), and the letter a will appear at the far right of the Play/Record MIDI Functions display.

**REMOTE VOICE PATCH SELECTION:
MIDI CHANNEL/VOICE PATCH/LIMIT**

CPL=1 001/064

To use MidiTrack III to remotely implement Voice Patch Changes on your synthesizer(s) from the computer keyboard, it is necessary to first configure your MidiTrack system for the synthesizers in your MIDI system.

When you boot MidiTrack III, the default setting for Channel/Patch/Limit (CPL=1 001/064) will be displayed. Reading from left to right, the first number in the CPL display indicates the current MIDI Channel, on which all Voice Patch Changes will be transmitted. The MIDI Channel selected must correspond to that selected on your synthesizer(s).



To increment the current MIDI Channel, while holding down SHIFT, hit L (**SHIFT + L**), until the desired MIDI Channel is displayed.



To decrement the current MIDI Channel, while holding down SHIFT, hit K (**SHIFT + K**).

The second, or middle, number in the CPL display indicates the current Voice Patch selected.

To increment the Voice Patch number displayed on the MidiTrack Screen and on your synthesizer, hit the X key repeatedly to cause the displays to step through the Voice Patch numbers one by one; or hold down the X key to quickly scan through the numbers, until the desired Voice Patch number is displayed. When the Voice Patch number has been incremented to the highest number available, if you hit X again, the display will wrap around to number 1.

To decrement the Voice Patch number, hit Z.

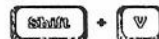

To enter a Voice Patch number using the numeric keys of the computer, while holding down SHIFT, hit V (**SHIFT + V**); then, enter any number within the available range, as designated by the Voice Patch Limit described below, and hit Return.

The third, or right-hand, number in the CPL display indicates the Voice Patch Limit; that is, the highest Voice Patch number, or total number of programs (or presets) available on the synthesizer to be addressed.

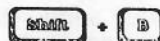

To set the Current Patch Limit, while holding down SHIFT, hit B (**SHIFT + B**). Then, enter a number between 1 and 127, and hit RETURN.

The program number displayed on your synth will not necessarily correspond to the Voice Patch number displayed on the MidiTrack Screen. Various synthesizers have different ways of designating program numbers. Some have consecutive numbering systems, others use only those numbers which consist of the numbers 1 through 8 (with zeros and nines omitted), and still others have banks of program numbers, requiring that the bank, then the program number be selected. Nevertheless, Voice Patch 1 on the MidiTrack Screen will always correspond to the lowest program number available on your synthesizer; incrementing the Voice Patch number on the MidiTrack Screen will cause the synthesizer to consecutively step through its program numbers; and the Voice Patch Limit number will represent the highest program number available on your synth.

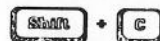

If, since last implementing a Voice Patch Change from the computer, you have changed the program on your synthesizer, to transmit the Voice Patch number currently displayed on the MidiTrack Screen to the synthesizer, via the MIDI Channel selected, while holding down SHIFT, hit C (**SHIFT + C**).

The following procedures will permit you to transmit a Voice Patch Change on all MIDI Channels, in order to implement a Voice Patch Change on all of the synthesizers in your MIDI system simultaneously, even when the synthesizers are assigned to different MIDI Channels:

To send the Voice Patch number currently displayed on the MidiTrack Screen via all MIDI Channels, hit C.

To increment the Voice Patch number on all MIDI Channels, hit N, for "Next," until the desired Voice Patch number is displayed.

To decrement the Voice Patch number on all MIDI Channels, hit B, for "Back."

To enter a Voice Patch number from the numeric keys of the computer and send it via all MIDI Channels, hit V; then, enter the Voice Patch number and hit RETURN.

Note: To simplify remote Voice Patch Changes that must be made during the course of a performance, load your voice programs into your synthesizers in the order in which they must be recalled (even if this requires that some programs be loaded more than once). Then, Voice Patch Changes may be made simply by stepping through the Voice Patch numbers in sequence.

MIDI RECORD CHANNEL

Rch=

MIDI Record Channel assignment allows you to record only that MIDI information received on the selected MIDI Channel: to record specific tracks from another MIDI sequencer; or to selectively record the output from a master controller keyboard with split keyboard capability, in which the MIDI data for each zone of the keyboard is transmitted on a different MIDI Channel; effectively filtering out MIDI data sent on MIDI Channels other than the one selected.

If no MIDI Record Channel has been selected, MidiTrack III will record incoming data on all MIDI Channels.

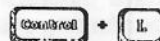

To increment the MIDI Record Channel, while holding down CONTROL, hit L (CONTROL + L).



To decrement MIDI Record Channel, while holding down CONTROL, hit K (CONTROL + K).

MEMORY REMAINING

Mem=100%

MidiTrack III provides a memory capacity of up to 21,000 MIDI events. When you boot your MidiTrack system, the Memory Remaining display indicates Mem=100%. As you record tracks, the percentage of Memory Remaining will be displayed, in round numbers, down to 1%. If the maximum memory capacity is exceeded, a "MEMORY LIMIT" message, written in inverse video, will appear on the blank line between the Thru=/IT= display line and the Sync= display line, and no further input will be accepted in Record Mode.

DRIVE INDICATOR

Drive=

Once the number of an alternate drive has been selected, the Drive indicator will appear at the bottom right-hand corner of the MidiTrack Screen. (See page 15).

4. PLAYING AND RECORDING TRACKS

Once your working copy of the MidiTrack III Master Disk has been loaded into the computer, the system is ready to begin recording. Before entering Play/Record Mode, set the BPM/Tempo (See Page 23) and activate the metronome if you so desire (See Page 26).

PLAY/RECORD MODE



To activate the Play/Record Mode, hit the SPACE BAR once. The Time Counter (T=0000.00) will begin to increment, indicating that the system's master clock is running. You may begin to play immediately after hitting the Space Bar; or, if you prefer, let the metronome count off a bar or two, then begin. If you make a false start, simply hit the SPACE BAR and try again. Hitting the SPACE BAR will zero the Time Counter and cause MidiTrack to reenter Play/Record Mode from the beginning of the song. As you play, MidiTrack will record all MIDI data received from your master controller keyboard into a Record Buffer.

Note: When recording a track, any Channel may be designated as the MIDI Thru Channel (See Page 25), enabling you to hear your record input from any synth in your MIDI system.

WARNING: Reentering Play/Record Mode, by hitting the SPACE BAR, will erase the contents of the Record Buffer. If you have played a good take on the previous pass, always Save the song data entered to an unused track before overdubbing your next track.

SAVING TRACKS

It is not essential that you make your track selection prior to entering Play/Record Mode. However, you must select an empty track, or one that you wish to erase, before performing the Save procedure.

WARNING: Saving song data to a track will write over any data currently residing on that track.

WARNING: Atari's keys repeat when held down. Holding down the INVERSE VIDEO key or entering the Save command twice will cause the Save to be made repeatedly, resulting in your saving an empty Record Buffer, overwriting the track just recorded. If this should occur, the Percentage of Memory Used for that track would read 00%.



When you have a good take, to Save the contents of the Record Buffer to the selected track, while holding down SHIFT, hit the INVERSE VIDEO key (**SHIFT + INVERSE VIDEO**).

When the Save has been successfully made, the Time Counter will return to the beginning of the song; that is, T=0000.00; and the Change indicator (c) and Percentage of Memory Used will appear on the track line.

PLAYBACK

After your song data has been saved, hit the SPACE BAR to listen to the playback of all recorded tracks or selected tracks, designated through the use of Solo or Mute on given tracks (See Page 20).

To stop playback, hit RETURN.

To resume playback from the same point in the song at which playback was stopped, hit TAB.

Note: The TAB key has a toggle function and may be used to stop playback, as well as to continue playback. However, all notes for which Note-Off commands have not been sent will persist until playback is resumed. When the RETURN key is used, Note-Off commands are sent for all notes currently playing.

5. SYNCHRONIZATION

SELECTING THE SYNC MODE

To select one of MidiTrack's five Sync Modes (Sync=), step through the Sync Mode options with successive hits of the S key, until the desired Sync Mode is displayed: Internal (int); External (ext); Single-Step (sst); MIDI; and TTL Clock, Roland Sync Clock or Beat Sync (joy). Optionally, each Sync Mode may be selected directly, by hitting the key corresponding to that Sync Mode, as delineated below.

INTERNAL SYNC

To select Internal Sync (int), in which the master clock provided by the MidiTrack system is governed by the BPM (Beats per Minute) Time Counter, hit the D key. The Sync display will read "Sync=int."

PROGRAMMABLE TEMPO CHANGES

Programmed Tempo Changes affect all clocks output by MidiTrack III, permitting devices slaved to MidiTrack to follow the Tempo Changes.

Any number of Tempo Change commands may be entered in Step Edit Mode (See Page 54), at any point in a song. It is recommended that you record Tempo Changes on a separate Control Track. For the procedures which may be used to advance to the points in a song at which Tempo Change commands are to be entered, refer to Step 3 of the Jump/Return Command Set, on Page 57. Programmed Tempo Changes will be heard on playback only when in the Internal Sync Mode (Sync=int). To enter a Tempo Change:

- 1) Set BPM to the desired Tempo, following the procedure outlined on Page 23.



- 2) To insert a Tempo Change command at the current location in a song, while holding down SHIFT, hit T (SHIFT + T). A "Change BPM" prompt will appear at the bottom of the screen.

WARNING: Saving Tempo Change data on a track will overwrite any data currently residing on that track. Select an empty track to be used as the Control Track.



3) To save a Tempo Change command, while holding down SHIFT, hit the INVERSE VIDEO key (**SHIFT + INVERSE VIDEO**). When the song playback has advanced to the exact location (beat and clock) of a programmed Tempo Change, the new BPM/Tempo will be displayed and the t indicator will appear in the space to the right of BPM= to indicate a Tempo Change.

Note: By recording a series of Tempo Change commands (no more than one per clock), a gradual Tempo Change may be created.

Note: Muting the Control Track will cause the programmed Tempo Changes to be disabled.

EXTERNAL SYNC

To select External Sync (ext), in which the master clock for the system is provided at the SYNC IN jack of the MidiMate Interface, hit the F key. The Sync display will read "Sync=int."

The input for External Sync may be received from the following sources: a Sync track, containing a standard clock or SMPTE code, previously laid down on tape to provide Sync to Tape; any standard clock generated by a non-MIDI drum machine or sequencer; or an audio trigger. When MidiTrack III is in External Sync (Sync=ext), the BPM display will not accurately reflect the tempo.

Note: Two MidiTrack systems may be driven by a single External Clock source.

THE EXTERNAL DIVIDER

Different manufacturers have established different clock standards for their equipment. The common time base for these standard clocks is 24 clocks per quarter-note beat. This standard is implemented for MidiTrack III, at the SYNC IN and OUT ports of the MidiMate Interface; as well as on drum machines made by E-mu Systems and Yamaha. The LinnDrum uses 48 clocks per beat, while the Oberheim System uses 96 clocks per beat.

When in External Sync, MidiTrack III is capable of accommodating all standard clocks through the use of an External Divider, which divides the incoming External Sync Clock into any user-designated standard clock, such as 48 or 96 clocks per beat.

The current External Divider is displayed as "edv=." The default value is edv=1, equivalent to 24 clocks per beat; that is, MidiTrack's standard clock of 24 clocks per beat, when divided (or multiplied) by 1, gives 24. Any number between 1 and 31 may be designated as the External Divider.

When MidiTrack receives the clock output of another device at the MidiMate Interface SYNC IN, the External Divider functions as a divider; that is, if the Sync input reads a standard clock of 48 clocks per beat, an External Divider of 2 will convert the input to 24 clocks per beat.

When using the MidiTrack master clock to record a Sync track on tape, the External Divider functions as a multiplier of the Sync output generated by MidiTrack III; that is, the 24-clocks-per-beat standard is multiplied: by 1, to give a Sync output of 24 clocks per beat; by 2, to output 48 clocks per beat; by 4, to output 96 clocks per beat.

Note: MidiMate's SYNC OUT is to be used ONLY when recording a Sync track onto tape.

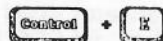

To enter the External Divider value, while holding down CONTROL, hit E (CONTROL + E); then, enter a number between 1 and 31, and hit RETURN.

LAYING DOWN A SYNC TRACK ON TAPE

For your MidiTrack system to Sync to Tape, it is first necessary to record a Sync track on your multitrack tape.

To lay down a Sync track on a multitrack tape:

- 1) Connect the SYNC OUT of the MidiMate Interface to a Record Input Channel on your multitrack tape recorder.
- 2) Enter the External Divider value.
- 3) Set the BPM/Tempo at which you wish to record the Sync track.

Note: When recording a sync track on tape, the frequency going to tape will be determined by the BPM setting (See Page 23) and the External Divider (See Page 36) The following formula may be used to determine the frequency appearing at the MidiMate's SYNC OUT:

$$\text{frequency} = \frac{\text{BPM (or Tempo)} \times \text{edv (External Divider)} \times 24}{60}$$

Note: When recording a sync track, optimal results may be achieved by using a frequency between 400Hz (Hertz) and 1kHz (kiloHertz). For example, specify an External Divider value of 10, at 120 BPM, to generate a square wave clock with a frequency of 480Hz at the SYNC OUT of the MidiMate Interface.; that is,

$$\text{frequency} = \frac{120 \times 10 \times 24}{60}$$

Most tape recorders are better able to record higher frequency clocks than very low frequency clocks, such as that which would be generated by using an External Divider value of 1, played at a slow tempo.

WARNING: Avoid using noise reduction (Dolby or dbx) when recording a Sync track. The pumping noise caused by the companding of the noise reduction unit can cause false triggering.

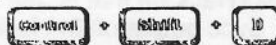

4) Check the record level of the Sync clock: To generate a clock signal at the SYNC OUT of the MidiMate Interface, while holding down CONTROL and SHIFT, hit D (**CONTROL + SHIFT + D**), then hit RETURN. For an optimal record level, the VU meter on the selected channel of your recorder should read between -5VU and -10VU. When the record level has been set, to stop the clock, hit ESC (Escape).

5) To make MidiTrack ready to generate a clock signal at the SYNC OUT of the MidiMate Interface, while holding down CONTROL and SHIFT, hit D (**CONTROL + SHIFT + D**).

6) Start the tape machine in Record Mode.

WARNING: To avoid the false triggering of your sequencers by the popping noise that is often generated when a tape machine is put into Record Mode, place the transport of the tape machine in record about ten seconds before causing a clock signal to be sent to tape.

7) Then, at the exact point on the tape at which you wish to start the clock, hit RETURN.

Note: The recording of the Sync track should start at a point on the tape at least ten seconds before the beginning of the song.



8) When a Sync Track of adequate length has been recorded, hit ESC (**Escape**) to stop MidiTrack's clock output; then hit any key to continue working from the MidiTrack Screen.

9) Stop the tape transport.

Note: When using the Sync track to drive your MidiTrack system, always initiate playback at a point on the tape prior to the beginning of the Sync clock.

SINGLE-STEP MODE

In Single-Step Mode (sst), in which a song may be entered one Step at a time or Step Editing may be performed, all Internal, External and MIDI Clocks are ignored. To select Single-Step Mode, hit the G key.



When in Single-Step Mode, the following commands are used to advance the Time Counter (T=0000.00) by steps:



To increment the Time Counter by a single clock, while holding down CONTROL, hit TAB (**CONTROL + TAB**).



To increment the Time Counter by a beat, while holding down SHIFT, hit TAB (**SHIFT + TAB**).

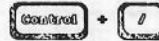

A programmable Step Value may be entered in clocks. The default is 06 clocks. To set the Step Value, while holding down CONTROL, hit the / key (**CONTROL + /**). The prompt "V step=" will appear at the bottom of the screen. Enter the Step Value in clocks, which may be any number between 1 and 96, and hit RETURN. The Step Value entered will appear to the right of the BPM setting.

To increment the Time Counter by this user-designated number of clocks, or programmed Step Value, hit the / key.

The Single-Step Mode commands used to increment the Time Counter are always active, regardless of the Sync Mode selected.

For more details on Step Editing, refer to Page 54.

MIDI CLOCK SYNC

Through the use of MIDI Clock Sync, two or more MidiTrack III system's, or other MIDI sequencers, and MIDI drum machines may be locked in sync. A MIDI Clock outputs 24 clocks per beat.



MidiTrack III may be slaved to a master clock output by another MIDI device. To select MIDI Clock Sync, in which the MIDI Clock received at the MIDI IN of the MidiMate Interface serves as the master clock for your MidiTrack system, hit the H key.

If MidiTrack III is to provide the master clock for your MIDI system, the Play MIDI Functions MIDI Start/Stop/Continue Commands (P/R=s/) must be enabled. The MIDI Clock will appear at the MIDI OUT of the MidiMate Interface whenever the Play MIDI Functions MIDI Start/Stop/Continue Commands are enabled, regardless of the Sync Mode selected. For the procedure used to enable the Play MIDI Functions MIDI Start/Stop/Continue Commands, refer to Page 26-28.

Note: Through the use of MIDI Sync, MidiTrack III may function as a Sync conversion unit.

SONG POSITION POINTER (SPP) AND STAR SEARCH

Note: Not all MIDI drum machines are capable of responding properly to Song Position Pointer and/or Star Search. Read this section of the manual thoroughly before attempting to implement either of these features.

A Song Position Pointer (SPP), output by a MIDI device providing the master clock for a MIDI system, communicates the exact point in a MIDI sequence at which a slave MIDI device capable of recognizing this MIDI spec, such as a drum machine or sequencer, is to start or stop. Using Song Position Pointer permits you to start playback at any point in a song. The Song Position Pointer may also be used to auto-locate to a point at which edits must be made in a sequence entered on another MIDI device.

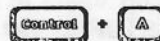

To activate Song Position Pointer, while holding down CONTROL, hit A (CONTROL + A).

When Song Position Pointer is active, a right-pointing arrow replaces the equal sign (=) in the Start Point Indicator (ST=). The presence of the equal sign indicates that the Song Position Pointer is inactive.

WARNING: Before attempting to use Star Search with your MIDI drum machine, it is advisable to save the contents of the drum machine's memory to a data tape or cartridge. When using Roland's TR-707 Rhythm Composer or TR-727, attempting to activate Star Search will erase the drum machine's memory.

To activate Star Search, through which a MIDI drum machine or another MIDI sequencer may be made to start simultaneously with MidiTrack III, again enter the command just used to activate Song Position Pointer; that is, while holding down CONTROL, hit A (CONTROL + A). An asterisk (*) will appear in place of the right-pointing arrow to indicate that Star Search is active.

By implementing Star Search, MidiTrack is made to send a MIDI Clock signal before the Start Point is reached. MidiTrack sends MIDI Clock data at a very high speed before the Start Point. If the MIDI drum machine being used is capable of matching MidiTrack's high "pre-roll" speed, MidiTrack and the drum machine will start their playback at the same time. Using Star Search will cause the drum machine to play at break-neck speed before the Start Point is reached. Star Search is, therefore, useful only in the studio.

Note: Sequential's Drumtraks and TOM are capable of responding to Star Search, but not to Song Position Pointer. Yamaha's RX11 and RX15 drum machines are capable of responding to neither Song Position Pointer nor Star Search. Roland's TR-707 and TR-727 will respond properly to Song Position Pointer, but, as noted above, will crash when Star Search is activated.

PROGRAMMING MIDI START/STOP/CONTINUE COMMANDS

Voice Program numbers above the range (from 0 to 127) designated by the MIDI specification may be used to implement other remote MIDI commands from the computer keyboard, including the programming of MIDI Start, Stop and Continue Commands. By entering these commands, other MIDI devices, such as drum machines and sequencers, may be remotely controlled by MidiTrack III. The same procedure used for Remote Voice Patch Selection may be used to program other MIDI commands into any track of a MidiTrack song. For the procedure used to implement Remote Voice Patch Selection, refer to Page 29.

To implement a single-step advance of the MIDI clock in slave MIDI devices, enter the Program number 249 (F8H).

A MIDI Start Command must be entered at the beginning of a bar. Locate a point at the beginning of a bar in your MidiTrack song, and the corresponding point in any other MIDI sequencer or drum machine, at which you wish MidiTrack III to send a MIDI Start Command. The other MIDI devices will start and play in sync with MidiTrack III from that point.

To transmit a MIDI Start Command, enter the program number 251 (FAH).

To transmit a MIDI Stop Command, enter the Program number 253 (FCH).

To send a MIDI Continue Command, enter the Program number 252 (FBH).

To send a Tune Request, enter the Program number 247 (F6H).

Note: Not all MIDI devices will respond to these MIDI commands. The Yamaha RX15 may be remotely controlled using these commands.

TTL CLOCK, ROLAND SYNC CLOCK AND BEAT SYNC

When you wish to sync a non-MIDI device to MidiTrack's Clock output, connect the device to the Atari computer's joystick port #1.

MidiTrack III is capable of sending, via the Atari's joystick port #1, a TTL (Transistor Transistor Logic) Clock output, which is a universal clock output, standard for microprocessor-based devices, as well as a Start/Stop signal. The TTL Clock output, which is compatible with a Roland Sync Clock, is transmitted only when MidiTrack is recording or playing back song data, and will function independently of the Sync Mode selected.

Note: A TTL Clock outputs the digital equivalent of a voltage pulse or square wave. Start is active low; that is, Start = 0V. The voltage remains low while the TTL Clock is being transmitted. Stop is active high; that is, Stop = 5V. However, this clock signal may have to be inverted for some machines, including Roland's instruments. Hitting the SPACE BAR should output a Start signal from MidiTrack III. If the unit reads this as a Stop signal, it will be necessary to invert the clock signal.

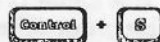

To select the polarity for the Start/Stop signal, while holding down CONTROL and SHIFT, hit S (**CONTROL + S**). This command will toggle between the polarities.

For use with Roland Sync, select Start active on high/Stop on low. When this polarity has been selected, an equal sign (=) will be seen in the Sync= display.

When Start active on low/Stop on high has been selected, the equal sign (=) in the Sync= display will appear in inverse video.

After the polarity for the Start/Stop signal has been selected, or after booting a MidiTrack working disk on which the polarity has been recorded, it is necessary to activate the Start/Stop signal polarity selected by hitting RETURN.

Note: The pulse of the clock output is very short, approximately 50 microseconds.

To slave MidiTrack to the clock output of a non-MIDI device, connect the device to the Atari computer's joystick port #2.

Two types of clock outputs may be received by your MidiTrack system via the Atari's joystick port #2: A TTL Clock output; and a Beat Sync output, in which one pulse is output per metronome beat.

Note: The joystick inputs are sampled only when Sync=joy. The clock-in and beat-in pins (See Appendix C) of joystick port #2 are sampled approximately 500 times per second; that is, once every 2 milliseconds. These inputs are active low. Provide a low-going pulse of about 5 milliseconds for either type of input.

Note: It is necessary to Sync through the joystick ports only when it is required that a TTL Clock be sent and received simultaneously.

To select the joystick port (joy) as the source of the Sync input, hit the J key.

For the proper way to connect a device through the joystick ports, see Appendix C.

6. EDITING

COPYING A TRACK

WARNING: When Copying a track to any other track, the data for the copy track will overwrite the data currently residing on the destination track. Always choose an empty track on which to save your copy track.

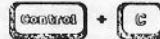

To Copy any track to any other track, without affecting the original track, while holding down CONTROL, hit C (**CONTROL + C**). The prompt "From tr #" will appear at the bottom of the screen. Enter a number between 1 and 16, followed by RETURN. Then the prompt "To tr #" will appear. Enter the number of the destination track and hit RETURN.

Note: Use this feature to move the contents of a track to another track:

To permit the arrangement of your tracks in a logical order, or the grouping of similar instruments, creating a rhythm section, horn section or string section.

To allow the editing of a track without altering the original. This feature permits unlimited experimentation, without jeopardizing your song data.

To create harmonies on another instrument, by transposing the copy track.

DELETING A TRACK



To Delete or erase a track, freeing the track, as well as space in memory, for new input, the track must first be selected; that is, the Track Pointer should be displayed to the left of the desired Track number. Then, while holding down CONTROL, hit D (**CONTROL + D**).

COMBINING TRACKS

To free additional tracks, it is possible to Combine, or bounce, up to sixteen tracks onto any empty track.

WARNING: When Combining Tracks, always choose an empty track on which to save the combined tracks, which would overwrite any data currently residing on the destination track.



To Combine Tracks, while holding down CONTROL, hit V (**CONTROL + V**). The prompt "Combine trs#" will appear at the bottom of the screen. Enter the numbers of the tracks to be combined, inserting a comma between each number, and hit RETURN. For example: 1, 3, 5, 7 RETURN. The prompt "To tr#" will now appear. Enter the number of the track onto which the tracks selected are to be bounced, then hit RETURN.

When the tracks have been combined, a Change indicator (c) will appear on the track line for the track on which the combined tracks now reside and the Percentage of Memory Used (00%) will change, reflecting the memory consumed by the combined tracks.

Note: The individual MIDI Channel Assignments of all the source tracks will be retained. Thus, tracks assigned to different MIDI Channels can be combined. Then, on playback, unless the entire track has subsequently been assigned to a MIDI Channel, overriding the individual MIDI Channel Assignments, the song data for each source track will be sent via the MIDI Channel to which that track was originally assigned. Of course, if you wish to do so, the combined track may be assigned to a new MIDI Channel.

EXTRACTING TRACKS



If you wish to restore tracks, previously Combined, to separate tracks, any song data for individual source tracks that were originally assigned to different MIDI Channels may be Extracted.

MIDI data assigned to a given MIDI Channel may be Extracted from a Combined Track by entering the following command sequence:

While holding down CONTROL, hit Y (**CONTROL + Y**). The prompt "Extract (-all but) Ch#" will appear at the bottom of the screen. Enter the number of the Channel to be extracted and hit RETURN.

If you wish to Extract all Channels, with the exception of one, enter a minus sign, followed by the Channel NOT to be extracted and hit RETURN; for example: -5, RETURN.

Then, the prompt "From tr #" will appear. Enter the number of the track on which the Combined Track resides and hit RETURN.

Next, the prompt "To tr #" will appear. Enter the number of the track to which the extracted track will be transferred and hit RETURN.

TRANSPOSITION

Transposition of any selected track by half-steps is provided over a range of five octaves, up or down. An octave is made up of twelve half-steps. The Transposition Range is from -60 half-steps (five octaves down) to 60 half-steps (five octaves up).

WARNING: Before entering the number of half-steps by which a track is to be transposed, make certain that the number falls within the range available on the keyboard on which the track is to be played back.

WARNING: When saving a transposed track to any track, including the source track, the data for the transposed track will overwrite the data currently residing on the destination track. Always choose an empty track on which to save the transposed version of the track.

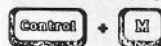

To Transpose, first, select a track. Then, while holding down CONTROL, hit M (**CONTROL + M**). The prompt "Transpose by #" will appear at the bottom of the screen. To Transpose Down, enter a minus sign, followed by the number of half-steps by which the track is to be transposed and hit RETURN. To Transpose Up, enter the number of half-steps by which the track is to be transposed and hit RETURN.

Then, you will be given the option to save the transposed version of the track to any other track. When the prompt "From tr #" appears, enter the number of the track which is to be transposed and hit RETURN. Then, the prompt "To tr #" will appear. Enter the number of the track to which the transposed version of the track is to be saved and hit RETURN.

Note: If you need to Transpose by a range of more than five octaves, simply perform this operation twice.

INSTANT TRANSPOSITION

Instant Transposition permits the simultaneous transposition of all of the 16 tracks over a range of more than an octave. This real-time function allows the key in which a song was entered to be changed on playback, to accommodate a singer or other solo instrument. Instant Transposition should be implemented before entering Playback Mode.

On the MidiTrack Screen, IT= indicates the number of half-steps by which a song is to be transposed, down or up, over a range from -8 half-steps through +7 half-steps.

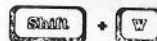

To decrement the key, or transpose Down by half-steps, implementing Instant Transposition for all tracks, while holding down SHIFT, hit W (**SHIFT + W**).

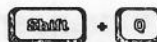

To increment the key, or transpose Up by half-steps, implementing Instant Transposition for all tracks, while holding down SHIFT, hit Q (**SHIFT + Q**).

Note: When Instant Transposition has been implemented, MIDI note data sent via MIDI Thru Mode is also transposed. Therefore, an accompaniment being played in real time at your master controller keyboard may be played in the key in which the song was originally recorded, while being heard at the synth output in the key to which the song has been transposed.

Note: Tracks used for recording unpitched song data, such as drum machine data, should not be transposed. When implementing Instant Transposition, you may designate a MIDI Channel which will remain unaffected by the transposition. All unpitched song data should be assigned to this MIDI Channel.

On the MidiTrack Screen, to the right of the number of half-steps by which the song is to be transposed, is displayed the number of the MIDI Channel not affected by Instant Transposition.

To select the MIDI Channel NOT to be affected by Instant Transposition, increment or decrement the number of the MIDI Channel displayed.



To increment the MIDI Channel number, while holding down SHIFT, hit R (**SHIFT + R**).



To decrement the MIDI Channel number, while holding down SHIFT, hit E (**SHIFT + E**).

Note: When no MIDI Channel number on which Instant Transposition is to be defeated has been selected, the default condition, in which all 16 MIDI Channels are transposed, will remain active. MidiTrack song data which is to be transmitted to a MIDI drum machine, or any other MIDI instrument capable of generating unpitched voices, should not be transposed.

QUANTIZATION

Quantization, or auto-correction, may be implemented after your tracks have been recorded, on any selected track, in order to correct the timing, relative to the beat.

MidiTrack III has a resolution of 24 clocks per beat; that is, a beat is divided into 24 clocks. Each beat is equivalent to a quarter note. A track may be quantized to the nearest whole, half, quarter, eighth, sixteenth or thirty-second note, or to any other user-designated Quantization Value between two and 120.

The note equivalents of various Quantization Values are as follows:

A Quantization Value of 96 is equivalent to a whole note.

48	a half note
24	a quarter note
16	a quarter-note triplet
12	an eighth note
8	an eighth note triplet
6	a 16th note
4	a 16th-note triplet
3	a 32nd note
2	a 32-note triplet

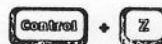

To implement Quantization, select the Track to be quantized; then, while holding down CONTROL, hit Z (**CONTROL + Z**). When the prompt "Quantize by #" appears at the bottom of the screen, enter a Quantization Value between 2 and 120, and hit RETURN. Then, the prompt "From tr #" will appear. Enter the number of the track to be quantized, followed by RETURN.

Note: When entering track numbers in response to these prompts, use the numbers one through 16. Do NOT use the QWERTY keys.

WARNING: When saving a quantized track to any track, including the source track, the data for the quantized track will overwrite the data currently residing on the destination track. It is recommended that an empty track always be chosen on which to save the quantized version of a track. Then, in the event that the quantized version is not to your satisfaction, it is possible to use the original version or to try quantizing the track using another Quantization Value.

Finally, the prompt "To tr #" will appear. Enter the number of the track to which you wish the quantized version of the track to be saved, followed by RETURN.

When the above command sequence has been entered, MidiTrack will begin processing the Quantization. During processing, the Note Activity Indicator will flash and the output to the synths will be muted. When Quantization has been completed, a Change indicator (C) will appear on the track line for the destination track on which the quantized track has been recorded and the Percentage of Memory Used (00%) will change to reflect the memory used by the quantized track.

7. AUTO-LOCATION

When Punching-In or Step Editing, Auto-Location permits you to play back a selected part of a song.

PROGRAMMING THE START POINT

The Start Point (ST=0000.00), or cue, for playback, may be set at any point between the beginning and end of the song.



To increment the Start Point by beats, while holding down the OPTION key, hit (or hold down) U (**OPTION + U**).



To increment the Start Point by clocks, while holding down OPTION and SELECT, hit U (**OPTION + SELECT + U**).



To decrement the Start Point by beats, while holding down the START key, hit U (**START + U**).



To decrement the Start Point by clocks, while holding down START and SELECT, hit U (**START + SELECT + U**).



To enter the Start Point using the numeric keys, while holding down OPTION and SELECT and START, hit U (**OPTION + SELECT + START + U**). When the prompt "ST=" appears, enter the Start Point; then, hit RETURN.

Note: When entering the Start Point, Punch-In Point, Punch-Out Point or End Point using the numeric keys: To enter a Point in beats, enter a number of up to four digits, not to exceed the limit of 2730, not followed by a decimal point. To enter a Point in beats and clocks, enter a number of up to four digits, followed by a decimal point, with two digits to the right of the decimal point. Since 24 clocks are equivalent to a beat, the number to the right of the decimal point should not exceed 23. To enter a Point in clocks, enter the decimal point and any two-digit number between 00 and 23.



During playback, to set the Start Point, to which you wish to Auto-Locate for playback, to the current value of the Time Counter, while holding down START and OPTION, hit U (**START + OPTION + U**).

PROGRAMMING THE END POINT

The End Point (EN=0000.00) may be set at any point after the Start Point to stop playback before the end of the song.

WARNING: If, after the End Point has been set, the Start Point is changed to a point after the End Point, the End Point will assume the value of the Start Point and playback will not be initiated.

Note: If the Punch-Out Point is inadvertently set at a point after the End Point, the End Point will assume the value of the Punch-Out Point and a successful punch can be completed. The End Point, by default, will have the same value as the Punch-Out Point, unless otherwise programmed.



To increment the End Point by beats, while holding down the OPTION key, hit (or hold down) P (**OPTION + P**).



To increment the End Point by clocks, while holding down OPTION and SELECT, hit P (**OPTION + SELECT + P**).



To decrement the End Point by beats, while holding down the START key, hit P (**START + P**).



To decrement the End Point by clocks, while holding down START and SELECT, hit P (**START + SELECT + P**).



To enter the End Point using the numeric keys, while holding down OPTION and SELECT and START, hit P (**OPTION + SELECT + START + P**). When the prompt "EN=" appears, enter the End Point; then, hit RETURN.

Note: Refer to Page 46 for the format to be used when entering the End Point with the numeric keys.



During playback, to set the End Point to the current value of the Time Counter, while holding down START and OPTION, hit P (**START + OPTION + P**).

USING AUTO-LOCATION

- 1) Program the Start and End Points, following the above procedures.
- 2) After the Start and End Points have been programmed, they may be Activated by hitting the A key. Consecutive hits of the A key will cause the display to step through the possible combinations of Start, Punch-In, Punch-Out and End Points, until the desired combination is displayed. In the default status, all of these Points are deactivated. On the MidiTrack Screen, Activated Points will move to the left, while inactive Points will remain at the right. To Activate the Start and End Points, hit A until both of these points move to the left in the display.



- 3) To cue the song to the Start Point, while holding down SHIFT, hit the SPACE BAR (**SHIFT + SPACE BAR**). At the far right of the Sync Mode display (Sync=), the letter w will appear to indicate that MidiTrack is waiting to begin playback until you hit the SPACE BAR.

- 4) When you hit the SPACE BAR to begin playback, the Waiting Indicator (w) will disappear. Playback will begin at the Start Point and stop at the End Point, as long as these points remain activated.

Note: When overdubbing a MidiTrack song data onto tape, Auto-Location permits you to start playback precisely on the beat.

Note: When rehearsing a punch or developing a musical part, Auto-Location may be put to efficient use. A great deal of time may be saved by playing back a selected portion of the song.

8. PUNCH-IN/PUNCH-OUT MODE:

Punch-In/Punch-Out editing may be implemented on any track to allow you to correct mistakes, without having to record the entire track over again, by overwriting the part of the track that falls between the Punch-In and Punch-Out Points.

- 1) When punching, Internal Sync (Sync=int) should ALWAYS be selected.
- 2) To prepare for automated Punch-In/Punch-Out editing, it is necessary to program a Start Point for playback that will allow sufficient pre-roll time before the Punch-In Point; to program the Punch-In and Punch-Out Points; and to program an End Point that provides the desired length of playback after the Punch-Out Point. For the procedures used to program the Start Point and End Point, refer to Page 47 and Page 48, respectively.

WARNING: The Punch-In and Punch-Out Points must be programmed with great care. Avoid the deletion of any essential MIDI Note-Off events. Deleting a Note-Off associated with a Note-On preceding the punch will result in a "hung" note, which will simply play FOREVER. If you should accidentally create a "hung" note, refer to Page 65 to solve your problem.

PROGRAMMING THE PUNCH-IN POINT

WARNING: The Start Point, Punch-In Point, Punch-Out Point and End Point must always be entered in the proper order; that is, in the order in which they are displayed on the MidiTrack Screen. If, after the Punch-In Point has been programmed, the Start Point is changed to a point after the Punch-In Point, the Punch-In Point will assume the value of the Start Point, as will the Punch-Out and End Points, if the Start Point has also been moved past these points, and playback will not be initiated.

The Punch-In Point (PI=) must follow the Start Point and precede the Punch-Out and End Points.



To increment the Punch-In Point by beats, while holding down the OPTION key, hit (or hold down) I (OPTION + I).



To increment the Punch-In Point by clocks, while holding down OPTION and SELECT, hit I (OPTION + SELECT + I).



To decrement the Punch-In Point by beats, while holding down the **START** key, hit **I** (**START + I**).



To decrement the Punch-In Point by clocks, while holding down **START** and **SELECT**, hit **I** (**START + SELECT + I**).



To enter the Punch-In Point using the numeric keys, while holding down **OPTION** and **SELECT** and **START**, hit **I** (**OPTION + SELECT + START + I**). When the prompt "PI=" appears, enter the Punch-In Point; then, hit **RETURN**.

Note: Refer to Page 46 for the format to be used when entering the Punch-In Point with the numeric keys.



During playback, to set the Punch-In Point to the current value of the Time Counter, while holding down **START** and **OPTION**, hit **I** (**START + OPTION + I**).

PROGRAMMING THE PUNCH-OUT POINT

WARNING: If, after the Punch-Out Point has been programmed, the Start Point and/or Punch-In Point are changed to a point after the Punch-Out Point, the Punch-Out Point will assume the value of the Start Point or Punch-In Point, respectively, as will the End Point, if the Start and/or Punch-In Points have been moved past the End Point, and playback will not be initiated.

The Punch-Out Point (PO=) must occur between the Punch-In Point and the End Point.



To increment the Punch-Out Point by beats, while holding down the **OPTION** key, hit (or hold down) **O** (**OPTION + O**).



To increment the Punch-Out Point by clocks, while holding down **OPTION** and **SELECT**, hit **O** (**OPTION + SELECT + O**).



To decrement the Punch-Out Point by beats, while holding down the **START** key, hit **O** (**START + O**).



To decrement the Punch-Out Point by clocks, while holding down START and SELECT, hit O (**START + SELECT + O**).



To enter the Punch-Out Point using the numeric keys, while holding down OPTION and SELECT and START, hit O (**OPTION + SELECT + START + O**). When the prompt "PO=" appears, enter the Punch-Out Point; then, hit RETURN.

Note: Refer to Page 46 for the format to be used when entering the Punch-Out Point with the numeric keys.



During playback, to set the Punch-Out Point to the current value of the Time Counter, while holding down START and OPTION, hit O (**START + OPTION + O**).

USING PUNCH-IN/PUNCH-OUT MODE

3) After the Punch-In and Punch-Out Points have been programmed, Punch-In/Punch-Out Mode may be Activated by hitting the A key. Consecutive hits of the A key will cause the display to step through the possible combinations of Start, Punch-In, Punch-Out and End Points, until the desired combination is displayed. In the default status, all of these Points are deactivated. On the MidiTrack Screen, Activated Points will move to the left, while inactive Points will remain at the right. To Activate the Punch-In/Punch-Out Mode, hit A until both of these points move to the left in the display. For automated punching, all four points must be activated; that is, aligned at the left of the display.

4) Next, to specify the number of the Track on which you wish to punch, hit the K key. The prompt "Ptr=" (Punch Track) will appear at the bottom of the screen. Enter a number between 1 and 16, using numeric keys only, and hit RETURN.

Note: If you intend to Save the punch on a track other than the Punch Track, as an extra safeguard, the Punch Track may be write-protected (See Page 22).



5) To cue the song to the Start Point, while holding down SHIFT, hit the SPACE BAR (**SHIFT + SPACE BAR**). The Waiting Indicator (w) will appear in the Sync Mode display and MidiTrack will wait to begin playback until you hit the SPACE BAR.

6) Now, as long as these points remain activated, to begin playback at the Start Point, hit the Space Bar.

Note: When automated punching is in use, you may play along during the pre-roll period. When the Punch-In Point is reached, MidiTrack will mute the Punch Track and automatically enter Record Mode. At the Punch-Out Point, MidiTrack will automatically drop out of Record Mode and unmute the Punch Track. Then, playback will continue to the End Point.

7) If you are not satisfied with your performance, simply repeat the above procedure.

8) When you have completed a good take, you may Save the entire track, including the punch, to the same track or to a different track. It is recommended that you Save the updated version of the track to a different track.

When the End Point has been reached, MidiTrack will automatically fast forward to the end of the track; then, copy the Punch Track into the Record Buffer. Wait until the Sync= display changes to stop, indicating that the system has finished processing the song data on the Punch Track.

Before Saving the Punch Track, it is first necessary to select the destination track (See Page 19).

WARNING: Saving song data to a track will overwrite any data currently residing on that track.

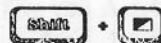

9) To Save the contents of the Record Buffer, including the punch, to the selected track, while holding down SHIFT, hit the INVERSE VIDEO key (**SHIFT + INVERSE VIDEO**).

When the Save has been completed, the Point indicators will move to the right, and Auto-Location and Punch-In/Punch-Out will be deactivated.

10) To start playback at the beginning of the song, hit the SPACE BAR.

Or, you may reactivate Auto-Location, by hitting A once, to hear just that part of the song between the Start and End Points. To cue the song to the Start Point, while holding down SHIFT, hit the SPACE BAR. Then, to start playback, hit the SPACE BAR again.

9. STEP EDIT MODE

Step Editing allows you to advance, by beats and/or clocks, to a specific point in a song, then to enter a note or any of the other MIDI events that can be entered in real time.



1) Before Step Editing may be accomplished, the Sync Mode must be designated as Single-Step Mode (Sync=sst), in which all Internal, External and MIDI Clocks will be ignored. To select Single-Step Mode, hit the G key.

When in Single-Step Mode, use CONTROL + TAB, to increment the Time Counter (T=0000.00) by a single clock; SHIFT + TAB, to increment the Time Counter by a beat; and the / key, to increment the Time Counter by a programmable Step Value.

Note: To program this Step Value, while holding down CONTROL, hit the / key (CONTROL + /). The prompt "V step=" will appear at the bottom of the screen. Enter the Step Value in clocks, which may be any number between 1 and 96, and hit RETURN. The Step Value entered will appear to the right of the BPM setting.



2) Auto-Location should be implemented for Step Editing. After setting the Sync Mode to Single-Step Mode, program both the Start Point (ST=) (See Page 47) and the Punch-In Point (PI=) (See Page 50) to occur at the beginning of the section to be edited. Then, program the Punch-Out Point (PO=) and the End Point (EN=) to occur at the end of the section to be edited.

WARNING: The Punch-In and Punch-Out Points must be programmed with great care. Avoid the deletion of any essential MIDI Note-Off events. Deleting a Note-Off associated with a Note-On preceding the punch will result in a "hung" note, which will simply play FOREVER. If you should accidentally create a "hung" note, refer to Page 65 to solve your problem.

3) To specify the Punch Track (Ptr=), hit the K key; then, enter the number of the Punch Track and hit RETURN.

4) Next, step through the song, pressing and releasing your synth's keys at the appropriate points, entering any other MIDI events desired, such as Program Changes or Controller data, as you go, until you have reached the end of the section to be edited. When the End Point has been reached, MidiTrack will automatically fast forward to the end of the track. Only when the system has stopped (Sync=sst stop), should the track be Saved.

5) Select a track upon which to Save the edited version of the source track.

Note: If only minor corrections have been made, the edited version may be Saved on the Punch Track to be repaired. When making major changes and/or additions to a track, the edited version should be Saved to an empty track, preserving the original track until you are certain that the edited track is satisfactory.

WARNING: Saving edited song data to a track will overwrite any data currently residing on that track.



6) To Save the edited version of the track to the selected track, while holding down SHIFT, hit the INVERSE VIDEO key (**SHIFT + INVERSE VIDEO**).

10. MOVE (OR "COPY AND PASTE")

Move may be used to "copy and paste" sections of a track, or an entire track, to any empty track, to any point in Time (forward or backward) in the song. Move provides a simple method for doubling the length of a track or chaining sections of a song.

1) The beginning and end of the section to be Moved are designated by the Start Point (ST=) and End Point (EN=), respectively. To set these points, refer to Page 47.

WARNING: The Start and End Points must be programmed with great care. Avoid the deletion of any essential MIDI Note-Off events. Deleting a Note-Off associated with a Note-On preceding the section of the track to be moved will result in a "hung" note, which will simply play FOREVER. If you should accidentally create a "hung" note, refer to Page 65 to solve your problem.

2) To implement Move, while holding down CONTROL, hit the Right Arrow key (CONTROL + -->).



3) The prompt "Move from tr #" will appear at the bottom of the screen. Enter the number of the source track and hit RETURN.

4) Then, the prompt "To tr #" will appear. Enter the number of the destination track and hit RETURN.

WARNING: Moving song data to another track will overwrite any data currently residing on that track.

5) When the "New ST=" prompt appears, enter the New Start Point, equivalent to the Time, in beats and clocks, at which the Moved section is to be placed, and hit RETURN. The section of the track designated by the Start Point and End Point will be moved to the New Start Point, which may occur at any point in time, previous to or later than the original Start Point.

Note: When the Move has been completed, you may Combine the source and destination tracks.

Note: When using Move, to insert or delete part of a track, Move the first part of the track to one destination track; Move the last part of the track to another destination track; then, Combine the two destination tracks.

PROGRAMMING DIGITAL DELAY EFFECTS

By Moving a section of a track or an entire track forward by very small increments, it is possible to create delay and echo effects.

11. THE JUMP/RETURN COMMAND SET

The Jump/Return Command Set may be used to implement an advanced and very flexible form of looping. A Jump Command placed at the end of the track to be looped, causes all of the song data on the track preceding the Jump Command to be repeated. By entering a Jump/Return Command Set, it becomes possible to Jump from any point on a track to the beginning of any other track in the song; then, to Return to the original point of departure. Any number of Jump/Return Command Sets may be recorded as part of a song, to create multiple repetitions or chain sections of a song in any order desired. By using Jump/Return Command Sets, which consume only the memory occupied by the Jump and Return Commands themselves, it becomes possible to program an extended song, while using virtually no additional memory.

SIMPLE LOOPING USING THE JUMP COMMAND

Programming a simple loop involves the use of only the Jump Command. A Jump Command should be placed at the end of the segment of the track to be looped, causing all of the song data on the track preceding the Jump Command to be repeated. To loop a track, use the following procedure:

- 1) When entering a Jump Command, Single-Step Mode (Sync=sst) should be selected by hitting the G key.
- 2) During playback, when the Jump Command is encountered on the track to be looped, playback will "Jump" to the beginning of the track. Therefore, it is necessary to Move the song data to the very beginning of the track; that is, to T=0000.00, in order to make the track "Jump Ready" (See Page 56).
- 3) Punch in to insert a Jump Command at the end of the track to be looped.

WARNING: When punching, all of the data currently residing between the Punch-In and Punch-Out Points will be overwritten. The Punch-In and Punch-Out Points must be programmed with great care to avoid erasing song data that you would wish to preserve. Advance past the song data to be looped and insert the Jump Command on an empty beat or clock. Especially avoid the deletion of any essential MIDI Note-Off events. Deleting a Note-Off associated with a Note-On preceding the punch will result in a "hung" note, which will play FOREVER. If you should accidentally create a "hung" note, refer to Page 65 to solve your problem.

Establish the Start, Punch-In, Punch-Out and End Points (See Page 47-51) required for the insertion of the Jump Command. Then, to advance to the location on the track at which the Jump Command is to be inserted; that is, to Auto-Locate to the Punch-In Point, while holding down SHIFT, hit the SPACE BAR (SHIFT + SPACE BAR).

4) To insert the Jump Command on the track, while holding down SHIFT, hit the Right Arrow (-->) key (SHIFT + -->). The prompt "Jump to start of track #" will appear at the bottom of the screen. Enter the number of the track to be looped; that is, the selected track; then, hit RETURN.

WARNING: Saving the song data on the track containing the Jump Command to the same track will overwrite the data currently residing on that track. It is recommended that the contents of the Record Buffer be saved to a different track. Then, should the looped version of the track be unsatisfactory, the original version will remain intact.

5) To Save the track containing the Jump Command, while holding down SHIFT, hit INVERSE VIDEO (SHIFT + INVERSE VIDEO).

EXAMPLE: After recording song data on (for example) Track 5, at the end of the track enter a "Jump to start of track 5" Command. On playback, Track 5 will play to the Jump Command; then, Jump to the beginning of Track 5, whereupon Track 5 will loop or repeat until playback is stopped.

USING THE JUMP/RETURN COMMAND SET

1) When using Jump/Return Command Sets, the Sync Mode should be set to Single-Step Mode (Sync=ss), by hitting the G key.

2) During playback, whenever a Jump Command is encountered on a track, playback will "Jump" to the beginning of the selected Destination Track. Therefore, it is necessary to Move the song data on all Destination Tracks to be incorporated in the Jump/Return Sequence to the very beginning of the track; that is, to T=0000.00, in order to make the tracks "Jump Ready" (See Page 56).

3) CREATING A DESTINATION TRACK

To create a Destination Track, a Return Command should be placed at the end of a track containing song data, to cause a Return to the point on the Control Track immediately following the last Jump Command executed.

a) Inserting a Return Command:

Method 1:

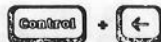

A simple and safe command sequence may be used to insert a Return Command into a track. While holding down CONTROL, hit the Left Arrow (<--) key (CONTROL + <--). The prompt "Add Return at T=" will appear at the bottom of the screen. Enter the point in the Destination Track at which the Return Command should be inserted and hit RETURN.

Note: Refer to Page 47 for the format to be used when entering the Return Point in beats and clocks using the numeric keys.

Next, the prompt "From tr#" will appear. Enter the number of the track and hit RETURN. Then, the prompt "To tr#" will appear. Enter the same track number and hit RETURN.

Method 2:

Alternatively, Punch In to insert a Return Command at the end of a track containing song data which is to be incorporated in the Jump/Return Sequence.

WARNING: When punching, all of the data currently residing between the Punch-In and Punch-Out Points will be overwritten. The Punch-In and Punch-Out Points must be programmed with great care to avoid erasing song data that you would wish to preserve. Advance past the song data and insert the Return Command on an empty beat or clock. Avoid the deletion of any essential MIDI Note-Off events. Deleting a Note-Off associated with a Note-On preceding the punch will result in a "hung" note, which will play FOREVER. If you should accidentally create a "hung" note, refer to Page 65 to solve your problem.

Establish the Start, Punch-In, Punch-Out and End Points (See Page 47-51) required to enter the Return Command. Then, to advance to the point on the track at which the Return Command should be entered; that is, to Auto-Locate to the Punch-In Point; while holding down SHIFT, hit the SPACE BAR (**SHIFT + SPACE BAR**).



To enter the Return Command, while holding down SHIFT, hit the Left Arrow (<-) key (**SHIFT + <--**). The RETURN indicator will appear briefly at the bottom of the screen whenever a Return Command is recorded.

WARNING: Be sure to select an empty track to be used as the Destination Track. Saving the song data, including the Return Command, to a track will overwrite any data currently residing on that track.

When the End Point has been reached, MidiTrack will automatically fast forward to the end of the track, then, copy the Punch Track into the Record Buffer. Wait until the Sync= display changes to stop, indicating that the system has finished processing the song data on the Punch Track.

b) To Save the Destination Track, which contains song data and ends with a Return Command, while holding down SHIFT, hit INVERSE VIDEO (**SHIFT + INVERSE VIDEO**).

4) All tracks containing Return Commands should be Muted. Otherwise, these tracks would sound at the beginning of playback.

5) CREATING A CONTROL TRACK

When implementing a Jump/Return Command Sequence it is best to use a Control Track; that is, an empty track dedicated solely to the recording of Jump Commands.

WARNING: Be sure to select an empty track to be used as the Control Track. Saving Jump Commands to the Control Track will overwrite any song data currently residing on that track.

a) Select a Control Track, using the numeric keys 1 through 0, for tracks 1 through 10, and the QWERTY keys, for tracks 11 through 16.

b) Insert a Jump Command:

Method 1:

Punch in to insert a Jump Command at the point desired.

WARNING: When punching, all of the data currently residing between the Punch-In and Punch-Out Points will be overwritten. The Punch-In and Punch-Out Points must be programmed with great care to avoid erasing song data that you would wish to preserve. Advance to a point immediately following the song data which is to precede the Jump Point and insert the Jump Command on an empty beat or clock. Avoid the deletion of any essential MIDI Note-Off events. Deleting a Note-Off associated with a Note-On preceding the punch will result in a "hung" note, which will play FOREVER. If you should accidentally create a "hung" note, refer to Page 65 to solve your problem.

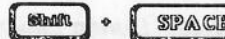

Establish the Start, Punch-In, Punch-Out and End Points (See Page 47-51) required for the insertion of the Jump Command. Then, to advance to the point on the track at which you wish to start the Jump/Return Command Sequence; that is, to Auto-Locate to the Punch-In Point; while holding down SHIFT, hit the SPACE BAR (**SHIFT + SPACE BAR**).

Method 2:

The Single-Step Mode commands may be used to position subsequent Jump Points on the Control Track: CONTROL + TAB, to increment the Time Counter (T=0000.00) by a single clock; SHIFT + TAB, to increment the Time Counter by a beat; and the / key, to increment the Time Counter by a programmable Step Value (See Page 54).



c) To insert a Jump Command on the Control Track, while holding down SHIFT, hit the Right Arrow (→) key (**SHIFT + →**). The prompt "Jump to start of track #" will appear at the bottom of the screen. Enter the number of the Destination Track and hit RETURN.

d) Any number of Jump Commands may be entered before saving the Control Track. If desired, song data may be recorded on the Control Track, between successive Jump Commands.

WARNING: Be sure to select an empty track to be used as the Control Track. Saving the Control Track data to a track will overwrite any data currently residing on that track.

When the End Point has been reached, MidiTrack will automatically fast forward to the end of the track, then, copy the Punch Track into the Record Buffer. Wait until the Sync= display changes to stop, indicating that the system has finished processing the song data on the Punch Track.

e) To Save the Control Track, which contains the Jump Commands, while holding down SHIFT, hit INVERSE VIDEO (**SHIFT + INVERSE VIDEO**).

PLAYING BACK THE JUMP/RETURN COMMAND SEQUENCE

To play back a song incorporating a Jump/Return Command Sequence, hit the SPACE BAR.

WARNING: All tracks containing Return Commands should be Muted, to prevent these tracks from sounding at the beginning of playback.

Note: On playback, the Time Counter will advance throughout the Jump/Return Command Sequence.

Note: During playback, on the Control Track, the track number displayed will change to reflect the number of the Destination Track currently playing.

ADDITIONAL JUMP/RETURN FEATURES

Note: Looped tracks and tracks entered in linear time may be played simultaneously. For example, loop your rhythm tracks, then overdub lead lines or sweetening on other tracks, without looping.

Note: To disable the Jump/Return Command Sequence, Mute the Control Track.



*Note: To Filter or Erase Jump or Return Commands embedded in a track, while holding down CONTROL, hit T (**CONTROL + T**). The prompt "Filter out Jumps>Returns -- From tr#" will appear at the bottom of the screen. Enter the number of the track containing the Jump or Return Commands and hit RETURN. Then, the prompt "To tr#" will appear. Again, enter the number of the track to be filtered and hit RETURN.*

SONG BUILDING USING JUMP/RETURN

By entering a Jump/Return Command Sequence, the various sections that make up a song, such as the Intro, Verse, Chorus and Bridge, may be caused to play, or repeat, in a selected order.

EXAMPLE: All tracks making up a given section of a song should be Combined on one track. As many as sixteen tracks may be Combined.

- 1) Combine all tracks making up the Verse onto (for example) Track 1. Move the Verse to the beginning (T=0000.00) of Track 1. Enter a Return Command at the end of Track 1.
- 2) Combine the Chorus tracks onto Track 2. Move the Chorus to the start of Track 2. Enter a Return Command at the end of Track 2.
- 3) Combine the Bridge tracks onto Track 3. Move the Bridge to the start of Track 3. Enter a Return Command at the end of Track 3.
- 4) Combine the Intro tracks onto Track 4. Move the Intro to the start of Track 4. Enter a Return Command at the end of Track 4.
- 5) On an empty track, for example, track 5, enter a "Jump to start of Track 4" Command, followed by a Jump to Track 1, Jump to Track 2, Jump to Track 1, Jump to Track 2, Jump to Track 3, Jump to Track 2 and another Jump to Track 2. Save this Control Track. Solo Track 5 and play the song. The sections of the song will play in the following order: Intro, Verse, Chorus, Verse, Chorus, Bridge, Chorus, Chorus.

Note: To enter a new section of music at the beginning of the song, after recording the song segment on Track 6, enter a "Jump to start of Track 5" Command at the end of Track 6. This will cause Track 6 to Jump to the start of the Control Track; that is, Track 5.

Note: If you wish to restore Combined tracks to separate tracks, any source tracks that were originally assigned to different MIDI Channels may be Extracted. When Combined tracks containing Jump or Return Commands are Extracted, each track extracted will incorporate all of the Jump or Return Commands present in the Combined track. If you later decide to again Combine these tracks, it is necessary to eliminate the Jump or Return Commands from all but one track before Combining the tracks. Otherwise, multiple Jumps would occur where originally just a single Jump was entered. To Filter or Erase Jump or Return Commands embedded in an Extracted track, refer to Page 43.

12. ADDITIONAL EDITING FUNCTIONS

SETTING OVERALL TRACK VELOCITY

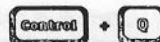

To change the Overall Track Velocity (output level or loudness) on the selected track, while holding down CONTROL, hit Q (**CONTROL + Q**). The prompt "Velocity=" will appear at the bottom of the screen. Enter a number between 1, which represents the lowest output level or Velocity, and 127, which represents the highest output level or Velocity, and hit RETURN.

Then, the prompt "From tr #" will appear. Enter the number of the source track, for which the Overall Track Velocity is to be set, and hit RETURN.

WARNING: Saving song data to a destination track causes all data currently residing on that track to be overwritten.

When the prompt "To tr #" appears, enter the number of the destination track, on which the Overall Track Velocity is to be set, and hit RETURN.

Note: Setting the Overall Track Velocity overrides the Velocity information originally recorded on the track using a Velocity-Sensitive keyboard. The output level for the track will remain at the static level specified by the Overall Track Velocity throughout.

By setting the Overall Track Velocity for non-velocity encoded tracks, it is possible to establish the levels of those tracks in the mix.

PROGRAMMING RELATIVE VELOCITY CHANGES

When used with keyboards on which Velocity-Sensitivity has been implemented, MidiTrack records velocity information.



To change the Relative Velocity of a track, up or down, WITHOUT affecting the Velocity changes originally recorded on that track using a Velocity-Sensitive keyboard, while holding down CONTROL, hit W (**CONTROL + W**). The prompt "+/- velocity" will appear at the bottom of the screen. Enter a value between 1 and 127, to increase the Velocity, or -1 and -127, to reduce the Velocity, and hit RETURN.

Then, the prompt "From tr #" will appear. Enter the number of the source track, for which Relative Velocity Change is to be programmed, and hit RETURN.

WARNING: Saving song data to a destination track causes all data currently residing on that track to be overwritten.

When the prompt "To tr #" appears, enter the number of the destination track, on which the Relative Velocity Change will be implemented, and hit RETURN.

SETTING AN OVERALL NOTE DURATION



To change all notes on a track to precisely the same duration, which may be shorter or longer than that of the notes originally entered, while holding down CONTROL, hit R (**CONTROL + R**). The prompt "Durate by #" will appear at the bottom of the screen. Enter a number between 1 and 240, the number of clocks equivalent to the desired note duration, and hit RETURN.

Then, the prompt "From tr #" will appear. Enter the number of the track for which the Overall Note Duration is to be set and hit RETURN.

WARNING: Saving song data to a destination track causes all data currently residing on that track to be overwritten.

When the prompt "To tr #" appears, enter the number of the destination track, to which the track affected by the Overall Note Duration will be saved, and hit RETURN.

Note: Uniform staccato or legato effects may be created by setting the Overall Note Duration.

Note: Setting an Overall Note Duration is an effective way of creating a pedal point, generally a bass part, made up of notes of long duration, sustaining over many measures.

Note: To set the Overall Note Duration for only a part of a track, it is first necessary to create the part which is to be assigned an Overall Note Duration and to set its Note Duration; then, by using Move, to build the track around the section which has been assigned an Overall Note Duration.

IDENTIFYING "HUNG" NOTE NOTES

In the event that a note gets stuck on, the Notes Display may be helpful in determining which is the "hung" note.

- 1) Solo individual tracks, during playback, until you are able to ascertain the track upon which the "hung" note occurs.
- 2) Solo the track upon which the "hung" note occurs.
- 3) During real-time or single-step playback, when the "hung" note is heard, call up the Notes Display. Playback will temporarily stop and the notes sounding when playback was stopped will be displayed at the bottom of the Notes Display screen. The MIDI Channel information displayed for each note may also be helpful in identifying "hung" notes.

EDITING "HUNG" NOTES

Once A "hung" note or notes have been identified, to remedy the "hung" note(s):

Method 1: The simplest procedure for remedying "hung" notes involves the insertion of a Return Command. When a Return Command is inserted on a track containing "hung" notes, Note-Off events will be automatically recorded for all notes sounding at the point at which the Return Command is inserted.

Note: If a Return Command is entered at a point on a track at which notes already having Notes-Offs are sounding, Inserting a Return Command for all notes sounding may create duplicate Note-Offs.

1) Determine the point at which the "hung" note(s) should end.

2) To insert a Return Command on the track containing the "hung" note(s) at the point at which the "hung" note(s) should end, while holding down CONTROL, hit the LEFT ARROW (<--) key (CONTROL + <--). The prompt "Add Return at T=" will appear at the bottom of the screen. Enter the point at which the Return Command should be inserted and hit RETURN.

Note: Refer to Page 47 for the format to be used when entering the Return Point in beats and clocks using the numeric keys.

Next, the prompt "From tr#" will appear. Enter the number of the track containing the "hung" note(s) and hit RETURN. Then, the prompt "To tr#" will appear. Enter the number of the destination track and hit RETURN.

3) To filter, or remove, the Return Command entered on the destination track, while holding down CONTROL, hit T (CONTROL + T). The prompt "Filter out Jumps>Returns -- From tr#" will appear at the bottom of the screen. Enter the number of the destination track and hit RETURN.

Then, the prompt "To tr#" will appear. Again, enter the number of the destination track and hit RETURN.

4) Mute the track containing the "hung" note(s). Then, play back the destination track, containing the edited version of the track, to verify that the "hung" note(s) have been successfully edited.

Method 2: "Hung" notes may also be remedied in Step Edit Mode, in which Note-Off(s) may be entered for specific note(s) at precisely the point on the track at which the Note-Off(s) should occur.

1) Prepare to punch in to enter a Note-Off for the "hung" note (See Page 52). Set the Start Point and Punch-In Point at the precise point at which the Note-Off should occur. The Punch-Out and End Points must be set at a point immediately following the Note-Off.

2) Before punching, verify that the MIDI Send Channel enabled on your master controller keyboard corresponds to the MIDI Channel which is indicated for the note in the Notes Display. If a MIDI Channel Assignment, as displayed on the MidiTrack Screen, is currently selected for the track, overriding any MIDI Channel information recorded on that track, the master controller keyboard may be assigned to any MIDI Channel.

3) To enter Single-Step Mode (Sync=sst), hit the G key.

4) Hold down the key or keys corresponding to the "hung" note or notes.

5) To cue the song to the Start Point, while holding down SHIFT, hit the SPACE BAR (**SHIFT + SPACE BAR**).

6) To enter the Note-Off or Note-Offs required, release the key or keys held down.

7) Enter Internal Sync Mode (Sync=int) by hitting the D key. MidiTrack will copy the Punch Track into the Record Buffer. Wait until the Sync= display changes to stop, indicating that the system has finished processing the song data on the Punch Track.

8) Save the edited version of the Punch Track to a different track. After selecting the destination track, to Save the contents of the Record Buffer, including the punch, to the selected track, while holding down SHIFT, hit the INVERSE VIDEO key (**SHIFT + INVERSE VIDEO**).

13. SYSTEM COMMANDS

TEST TONES

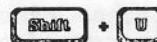

To test MidiTrack III's output to your synths by sending a series of Test Tones on the current MIDI Channel, which is the first number displayed after CPL=, while holding down SHIFT, hit U (**SHIFT + U**).

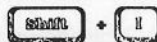

To successively send the Test Tones on all MIDI Channels, while holding down SHIFT, hit I (**SHIFT + I**).

By sending the Test Tones via all MIDI Channels, MidiTrack's output to all of your synths may be checked, ensuring that all connections have been properly made, that the correct MIDI Channel Assignments have been made and that the desired Voice Patch has been selected.

MIDI TUNE REQUEST

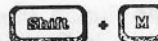

To send a MIDI Tune Request, which will cause analog synths capable of recognizing this MIDI Command to enter their tuning routines, while holding down SHIFT, hit M (**SHIFT + M**).

MIDI MODE SELECTION

MIDI Mode Selection is fully implemented in MidiTrack III. The MIDI Mode selected determines the way in which a MIDI-equipped instrument will respond to incoming MIDI Channel Messages.



In OMNI OFF/POLY MODE, to which MIDI instruments in a MIDI system will generally be assigned, an instrument will respond polyphonically only to MIDI information sent via the MIDI Channel to which it is assigned. To send an OMNI OFF/POLY MODE command on all MIDI Channels, while holding down SHIFT, hit H (**SHIFT + H**).

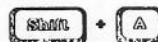

To send an OMNI OFF command on the current MIDI Channel, while holding down SHIFT, hit A (**SHIFT + A**).

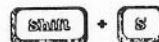

To send an OMNI ON command on the current MIDI Channel, causing instruments assigned to that Channel to respond to MIDI information sent via all Channels, while holding down SHIFT, hit S (**SHIFT + S**).



To send a MONO command on the current MIDI Channel, causing instruments assigned to that Channel to respond monophonically, while holding down SHIFT, hit D (**SHIFT + D**).



To send a POLY command on the current MIDI Channel, causing instruments assigned to that Channel to respond polyphonically, while holding down SHIFT, hit F (**SHIFT + F**).

ADDITIONAL MIDI COMMANDS

The three following commands may be useful in the event a note should get stuck on:



1) To send an All Notes Off command on the current MIDI Channel, causing instruments assigned to that Channel to turn off all notes currently sounding, while holding down SHIFT, hit G (**SHIFT + G**). Not all MIDI instruments will respond to this command.



2) A special MidiTrack III command will cause Note-Offs to be transmitted for each note currently sounding; while holding down CONTROL, hit X (**CONTROL + X**). Under certain circumstances, pertaining to the current status of MidiTrack III, the MIDI instruments making up your MIDI system may not respond to this command.

3) Sending an OMNI OFF/POLY command on each MIDI Channel will also turn off all notes currently sounding. This method is effective for all MIDI instruments.



To send a Zero Pitch-Bend Wheels and Controllers (modulation wheel) command on all MIDI Channels, while holding down SHIFT, hit J (**SHIFT + J**).

The MIDI Local Off command permits a master keyboard controller to be played without causing its sound circuitry to generate any audio output, while transmitting MIDI data to control the sound output of another instrument. The sound circuitry of the master keyboard controller may at the same time receive MidiTrack song data, by which its sound output may be controlled. To transmit a Local Off command on the current MIDI Channel, while holding down SHIFT, hit O (**SHIFT + O**). MidiTrack's MIDI Thru Mode should also be implemented (See Page 25).

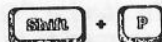

To transmit a Local On command on the current MIDI Channel, to counteract a previous Local Off command, while holding down SHIFT, hit P (**SHIFT + P**). Local On/Off is not implemented on all MIDI instruments.

NOTES DISPLAY

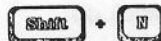

When in real-time or single-step playback, to call up the Notes Display Screen, while holding down SHIFT, hit N (**SHIFT + N**). Playback will stop and all notes last sounding will be shown at the bottom of a scrolling screen display. Note information for muted tracks will not be displayed. To view the notes on an individual track, prior to calling up the Notes Display Screen, solo the desired track and only the notes on that track will be displayed.

The note information displayed includes the note, natural (no sign) or sharp (#), octave (middle C = C4), and the number of the MIDI Channel via which the note is being sent.

To resume playback, hit "any key to return" to Play/Record Mode.

RESET

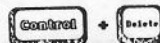

WARNING: Before beginning work on a new song, the song on which you had been previously working must be Saved to disk (See Page 14).

In preparation for beginning a new song, the MidiTrack Screen must be cleared.

To perform a system Reset, thereby clearing the MidiTrack Screen, while holding down CONTROL, hit DELETE (**CONTROL + DELETE**). All data currently residing in RAM (Random Access Memory) will be erased.

RESTORING WORKING DISK PARAMETERS

To restore all of the parameters resident on a working disk when it was booted, hit the DELETE/BACK SPACE key.

Figure #1

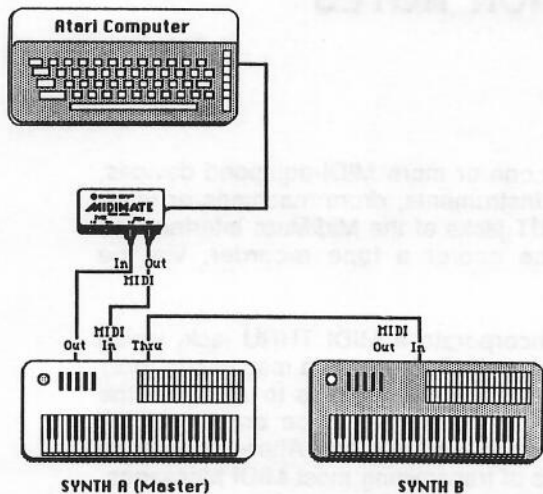

Figure #2

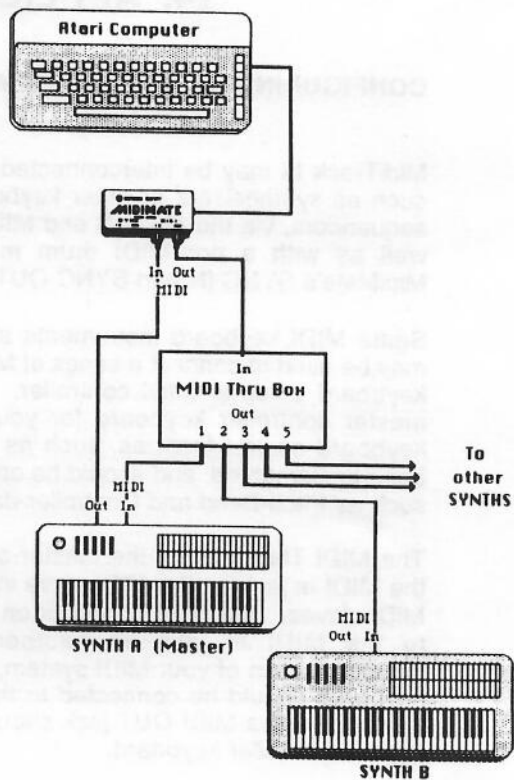
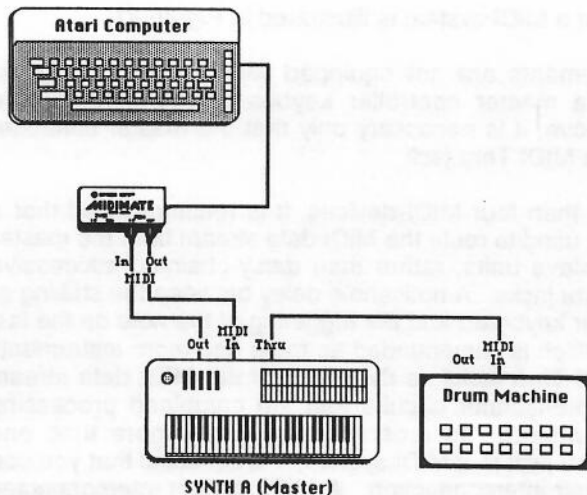

Figure #3



14. APPLICATION NOTES

CONFIGURING A MIDI SYSTEM

MidiTrack III may be interconnected with one or more MIDI-equipped devices, such as synthesizers or other keyboard instruments, drum machines or other sequencers, via the MIDI IN and MIDI OUT jacks of the MidiMate Interface, as well as with a non-MIDI drum machine and/or a tape recorder, via the MidiMate's SYNC IN and SYNC OUT.

Some MIDI keyboard instruments also incorporate a MIDI THRU jack, which may be used to connect a series of MIDI slave instruments to a master controller keyboard or other MIDI controller. The instrument which is to serve as the master controller keyboard for your MIDI system should be one on which keyboard control features, such as Velocity-Sensitivity and After-Touch have been implemented, and should be capable of transmitting most MIDI Messages, such as Pitch-Bend and Controller data, and Program Change.

The MIDI Thru jack on the master controller keyboard should be connected to the MIDI In jack on the MIDI slave instrument, or on the first of a daisy chain of MIDI slaves. The MIDI Thru jack on the first slave would, in turn, be connected to the MIDI In jack on another slave instrument. To complete the interconnection of your MIDI system, the MIDI Out jack on the master controller keyboard should be connected to the MIDI IN jack on the MidiMate Interface. The MidiMate's MIDI OUT jack should be connected to the MIDI In jack on the master controller keyboard.

The proper interconnection of a MIDI system is illustrated in Figure #1.

Many MIDI keyboard instruments are not equipped with a MIDI Thru jack. However, to interconnect a master controller keyboard to a single slave instrument, as described above, it is necessary only that the master controller keyboard be equipped with a MIDI Thru jack.

When interconnecting more than four MIDI devices, it is recommended that a MIDI Thru Box, or splitter, be used to route the MIDI data stream from the master controller keyboard to the slave units, rather than daisy-chaining successive instruments via their MIDI Thru jacks. A noticeable delay between the striking of a key on the master controller keyboard and the triggering of the note on the last keyboard in a daisy chain, which is compounded as more and more instruments are connected via their MIDI Thru jacks, is the result of the MIDI data stream passing through multiple opto-isolator circuits and the combined processing time of the individual instruments. In order to incorporate more than one instrument lacking a MIDI Thru jack in a MIDI system, it is essential that you use a MIDI Thru Box to effect their interconnection. A MIDI system interconnected via a MIDI Thru Box is illustrated in Figure #2.

Note: When using more than one synthesizer, before you begin to play, transmit an OMNI OFF/POLY command on all MIDI Channels by holding down SHIFT and hitting H (SHIFT + H). Each MIDI instrument in your MIDI system will respond polyphonically only to MIDI data transmitted on the MIDI Channel to which it has been assigned.

USING MIDI DRUM MACHINES WITH MidiTrack III

When MIDI Clock Sync (Sync=MIDI) has been selected, MidiTrack III will transmit a MIDI Clock signal, via the MidiMate's MIDI OUT, which may be used to synchronize your MIDI drum machine with MidiTrack III (See Page 38). It is recommended that MidiTrack III always be used to provide the master clock for your MIDI system. When MidiTrack III is being used as the master and Play/Record Mode is entered, by hitting the SPACE BAR, your slave MIDI drum machine and/or slave MIDI sequencer will automatically start and play in sync with MidiTrack.

Note: Before implementing MIDI Clock Sync, it is necessary to program your MIDI drum machine to receive the MIDI Clock signal transmitted by MidiTrack III. Please refer to the manual for your drum machine to ascertain the proper procedure to be used when programming the drum machine to receive a MIDI Clock signal.

When syncing to tape (See Page 36), MidiTrack III will sync to the clock signal on tape and step through a song; again, causing your slave MIDI devices to start and play in sync. In the same way, MidiTrack's internal clock or any non-MIDI external clock or trigger may be used to drive MidiTrack III, while MidiTrack III provides the master clock for all slave devices. When receiving any External Sync signal at the MidiMate's SYNC IN, MidiTrack III simultaneously outputs a MIDI Clock signal, a TTL Clock signal, as well as a Start/Stop signal, and an audio click.

When MidiTrack III is to function as the master, to which a MIDI drum machine is to be slaved, the MidiMate's MIDI OUT jack should be connected to the MIDI In jack on the drum machine.

The proper interconnection of MidiTrack III with a MIDI drum machine is illustrated in Figure #3.

Note: The same configuration, illustrated in Figure #3, may be used when interconnecting MidiTrack III with another MIDI sequencer or additional MidiTrack systems.

Figure #4

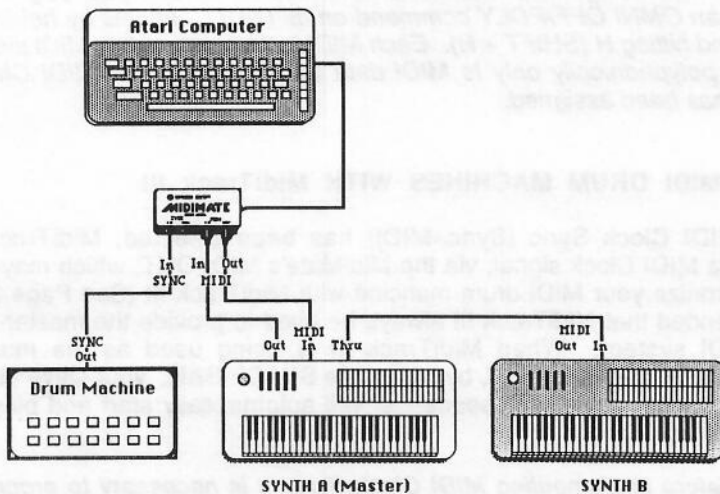
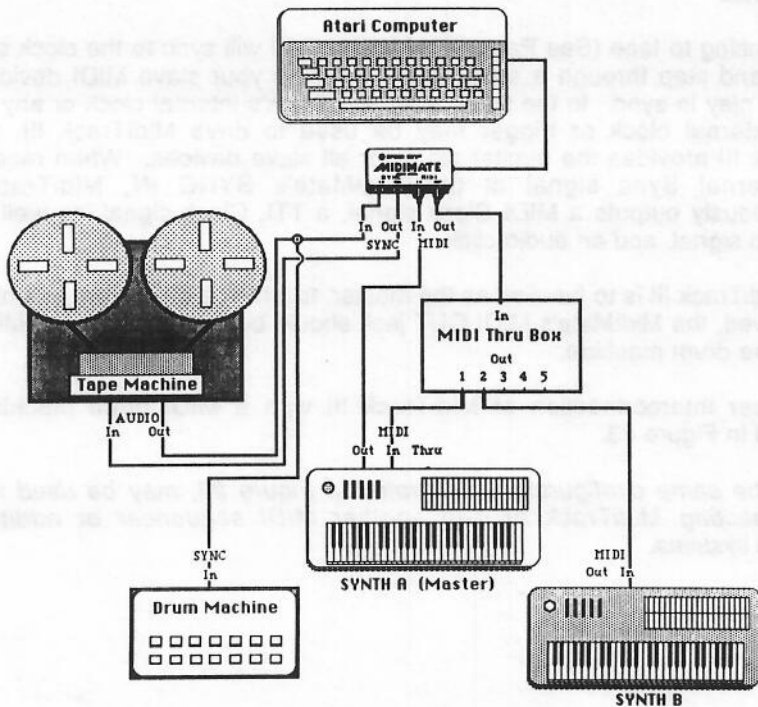

Figure #5



HELP FOR YAMAHA RX11 & RX15 USERS:

To implement MIDI Clock Sync on Yamaha RX drum machines, while holding down the FUNCTION key, hit the SYNC key. The LCD display will indicate one of the following Sync Modes: "INTERNAL CLOCK," "MIDI CLOCK" or "EXTERNAL CLOCK." Hit the DECREMENT (-1) key until "MIDI CLOCK" is displayed. Then, hit the SYNC key again to enter the Sync Mode selected.

HELP FOR ROLAND TR-707 & TR-727 USERS:

To implement MIDI Clock Sync on Roland's TR series of drum machines, while holding down the SHIFT key, hit the SYNC key until "Sn" (for Sync) appears in the display.

DRUM MACHINE SYNC (For Non-MIDI Drum Machines)

The master clock for your MidiTrack III system may be provided by an external device, such as a non-MIDI drum machine. To select External Sync Mode, refer to Page 35. Specify the External Divider as 1 ($edv=1$) for the greatest accuracy. The greater the number of clocks transmitted by your drum machine per beat, the greater its resolution, or accuracy. Using a drum machine capable of transmitting an external clock of 96 clocks per beat will provide a resolution four times greater than that provided by a drum machine which transmits only 24 clocks per beat.

The drum machine's clock output should be connected to the SYNC IN of the MidiMate Interface, as is illustrated in Figure #4. Your synthesizers may be connected as illustrated in either Figure #1 or #2.

After you hit the SPACE BAR, MidiTrack III will wait until it receives an external clock from the drum machine. Start the drum machine. The clock output of the drum machine will trigger MidiTrack III, which will start in sync with the drum machine. Proceed with your recording as usual. After saving your song (See Page 14), to begin playback, again hit the SPACE BAR; then, start the drum machine.

TAPE SYNC

Select an External Divider of 1 ($edv=1$) to record a sync track with a time base of 24 clocks per beat, which is compatible with the E-mu Drumulator; an External Divider of 2 ($edv=2$), for 48 clocks per beat, which is compatible with the LinnDrum; or an External Divider of 4 ($edv=4$), for 96 clocks per beat, which is compatible with Oberheim drum machines.

After you have recorded a sync track on your multitrack tape, to use the sync track as the external master clock for your MidiTrack system, select External Sync (See Page 35).

As illustrated in Figure #5, the audio output of the tape machine should be connected to MidiMate's SYNC IN, while MidiMate's SYNC OUT should be connected to the audio input of the tape machine.

After you hit the SPACE BAR, MidiTrack will wait for an external clock signal. Place the transport of your tape machine in playback mode. The sync track will trigger MidiTrack III, which will start in sync with the sync track.

Before playing back your song, rewind the tape to the beginning of the sync track. Then, hit the SPACE BAR and start the tape in playback mode.

Additional tracks may be recorded on MidiTrack III, as well as on the multitrack tape. Thus, MidiTrack functions as a recorder for synthesized tracks, while vocals and acoustic or electric instruments are recorded on tape.

When MidiTrack sequencing and tape overdubs have both been completed, record the final mix on a two-track tape machine with MidiTrack III locked in sync to your multitrack tape machine.

USING 48 or 96 CLOCKS PER BEAT

MidiTrack III is capable of syncing to external clocks of 48 or 96 clocks per beat. No external synchronizer is required.

Connect the clock output of your drum machine, or the output of the sync track on your tape machine, to MidiMate's SYNC IN.

To sync to an external clock or sync track with a time base of 48 clocks per beat, select External Sync (See Page 35) and an External Divider of 2 (edv=2) (See Page 35). The external clock will be divided by two, emulating MidiTrack's 24-clocks-per-beat time base.

To sync to a signal with a time base of 96 clocks per beat, select an External Divider of 4 (edv=4).

Note: For really tight timing, double the BPM and count 48 clocks per quarter-note beat.

USING SMPTE TIME CODE

MidiMate's SYNC IN is capable of reading a low-level, -25VU signal from a tape machine. Because of the flexibility of MidiTrack's time base in External Sync, as designated by the value assigned to the External Divider (edv=), MidiTrack may be used to sync to SMPTE time code. In order for MidiTrack to synchronize to SMPTE, it is necessary to start MidiTrack from the beginning of the SMPTE time code.

First, select External Sync (See Page 35). To enable MidiTrack III to read SMPTE time code, the External Divider must be set to a value of 5 or greater (See Page 35). Experiment with different values until one is found that matches the SMPTE signal being received.

AUTOMATED MIXING USING MIDI VOLUME

MidiTrack III is capable of recording MIDI Volume, one of the 128 MIDI Controllers. To implement MIDI Volume, enable the Playback and/or Record MIDI Controllers (see page 26). If the instruments being driven by MidiTrack provide control of MIDI Volume, automated mixing may be implemented.

Note: Refer to your instruments' manuals to determine whether or not provision has been made for the control of MIDI Volume.

APPENDIX A: Understanding the MIDI Specification

MIDI, an acronym for **Musical Instrument Digital Interface**, has been adopted as a convention by the major synthesizer manufacturers to allow communication between their microprocessor-based synthesizer devices and computers. The MIDI specification standardizes MIDI hardware and establishes a software protocol.

A MIDI circuit is an opto-isolated current loop. To prevent ground loops and noise pickup, each MIDI receiver is equipped with an opto-isolator, a unit that modulates data on light beams emitted by an LED (Light Emitting Diode) optically coupled with a photo-transistor, and, therefore, electronically isolated from the data source. MIDI hardware devices are connected, via their MIDI In, Out and Thru ports, by 5-pin DIN plug MIDI cables. The MIDI Thru port of a MIDI device outputs a MIDI data stream which is identical to that received at its MIDI In. Only the MIDI data originating in a MIDI device is transmitted by its MIDI Out port.

MIDI is an asynchronous serial interface; that is, it sends one bit (binary digit, 1 or 0) at a time, and each transmission consists of a start bit, eight data bits and a stop bit, which together make up a MIDI byte, or digital word. MIDI transmits data at a rate of 31.25 kilobaud, or 31,250 bits per second. The receiving device strips off the start and stop bits, then processes the incoming MIDI data. Each pair of Note-On/Note Off Messages is made up of six bytes. Therefore, MIDI is capable of transmitting up to 520 notes per second.

Only 256 different combinations of eight bits are possible. To increase the number of MIDI messages beyond this limitation, the MIDI specification defines two basic types of MIDI bytes: Status bytes, in which the MSB (Most Significant Bit) is a one, that communicate to the MIDI receiver how the MIDI Data bytes which follow should be interpreted; and the Data bytes, in which the MSB is a zero, that may be interpreted in many different ways, depending on which is the preceding Status byte. Each MIDI Message consists of a Status byte followed by one or two Data bytes.

Status bytes are used to send Channel Messages, in which one of 16 MIDI Channels is designated to receive the MIDI data being sent; and System Messages, including: Common Messages, universal commands, such as Tune Request, which are sent on all MIDI Channels; Real-Time Messages, consisting of timing information used to synchronize the various MIDI devices in a MIDI system, which are sent on all MIDI Channels, preempting all other MIDI messages; and Exclusive Messages, which are used by individual manufacturers to implement functions for which there is no provision in the MIDI specification.

How a MIDI-equipped instrument will respond to incoming Channel Messages is determined by which of the four MIDI Modes is selected on that instrument. An instrument in Omni-On Mode will receive MIDI messages on all channels. In the Omni-Off Mode, an instrument responds only to MIDI messages on the channel to which it is assigned. In Mono Mode, an instrument responds monophonically, and in Poly Mode, polyphonically.

Through MIDI, two or more synthesizers may be interconnected, then played via a master controller keyboard or a sequencer, such as your MidiTrack III system. With 16 assignable MIDI Channels, as many as 16 MIDI-equipped synthesizers, or 16 banks of MIDI synths, may be individually addressed. When using MidiTrack III to record or playback songs, any track may be assigned to any MIDI channel, to drive any MIDI synthesizer(s) set to receive that channel. MidiTrack III transmits on all 16 channels simultaneously. To see some examples of MIDI systems, refer to Application Notes, on Page 71.

A MIDI digital data stream is output by the synthesizer as you play. As designated by the MIDI specification, each function of the synthesizer has its data equivalent, known as a MIDI event. Synthesizer functions which may be sent over MIDI include: Note On, which indicates the note played and the velocity with which the note is played; Note Off, indicating the note and its release velocity; After-Touch; Pitch-Bend; Controller, implementing the selection of a controller, such as the modulation wheel, breath controller, volume, or sustain pedal, and its current value; and Program Change, for the selection of voice patches.

Appendix B MidiTrack III Commands

TRACKS:

1 through 9	- Tracks 1 through 9
0-Track 10	
Q	- Track 11
W	- Track 12
E	- Track 13
R	- Track 14
T	- Track 15
Y	- Track 16
UP ARROW	- Track on
DOWN ARROW	- Track off (mute)
CONTROL + UP ARROW	- All tracks on
CONTROL + DOWN ARROW	- All tracks off
SHIFT + UP ARROW	- Solo this track
SHIFT + DOWN ARROW	- All tracks on except this one
CONTROL + SHIFT + DOWN ARROW	- Down a track and solo
CONTROL + SHIFT + UP ARROW	- Up a track and solo
CONTROL + 5	- Save current mute status to mute register 5
CONTROL + 6	- Save current mute status to mute register 6
CONTROL + 7	- Save current mute status to mute register 7
Shift + 5	- Recall mute status from register 5
Shift + 6	- Recall mute status from register 6
Shift + 7	- Recall mute status from register 7

PROTECTING:

CONTROL + P	- Protect current track
CONTROL + SHIFT	- Unprotect current track

CHANNELS:

CONTROL + SHIFT + 1	through 9	- Select MIDI channel 1 through 9
CONTROL + SHIFT + 0		- Select MIDI channel 10
CONTROL + SHIFT + Q		- Select MIDI channel 11
CONTROL + SHIFT + W		- Select MIDI channel 12
CONTROL + SHIFT + E		- Select MIDI channel 13
CONTROL + SHIFT + R		- Select MIDI channel 14
CONTROL + SHIFT + T		- Select MIDI channel 15
CONTROL + SHIFT + Y		- Select MIDI channel 16
CONTROL + SHIFT + U		- Deselect MIDI channel

SYNC:

S		- Change sync status (rotate through)
D		- int = Internal
F		- ext = External (SYNC IN on MidiMate)
G		- sst = Single step
H		- midi = MIDI clock in
J		- joy = Joystick input port
CONTROL + E		- External divide select (1 to 31)
CONTROL + SHIFT + D		- Lay down a clock signal (SYNC OUT)
CONTROL + SHIFT + S		- Toggles Joystick Start / Stop polarity

TEMPO:

<		- Decrement BPM
>		- Increment BPM
SHIFT + <		- Decrement BPM by 10
SHIFT + >		- Increment BPM by 10
CONTROL + 8		- Save current tempo to tempo register 8
CONTROL + 9		- Save current tempo to tempo register 9
CONTROL + 0		- Save current tempo to tempo register 0
SHIFT + 8		- Recall tempo from tempo register 8
SHIFT + 9		- Recall tempo from tempo register 9
SHIFT + 0		- Recall tempo from tempo register 0
CONTROL + B		- Enter BPM manually (2 to 750)
SHIFT + T		- Insert programmable Tempo Change command

METRONOME:

M		- Change metronome status
		v=Visual
		c=Click

SETTING TIMES:

Ü
I
O
A P

- Set start time *
- Set punch in time *
- Set punch out time *
- Set end time *

* Function keys are used with the above

- | | |
|-------------------------|--|
| START | - Decrement by beats |
| OPTION | - Increment by beats |
| START + SELECT | - Decrement by clocks |
| OPTION + SELECT | - Increment by clocks |
| START + OPTION | - Set to current time (while in play or stopped) |
| START + SELECT + OPTION | - Enter time |

PUNCH IN / PUNCH OUT

- | | |
|-------------|--|
| A | - Change ST / EN and PI / PO logic |
| CONTROL + A | - Toggle MIDI clock mute, Song Position Pointer, and Star Search modes |
| K | - Enter punch track |

EDITING COMMANDS:

- | | |
|-----------------------|------------------------------------|
| CONTROL + C | - Copy track |
| CONTROL + D | - Delete current track |
| CONTROL + V | - Combine tracks |
| CONTROL + M | - Transpose (+ or - 60 half steps) |
| CONTROL + Z | - Quantize timing |
| CONTROL + R | - Set duration of notes (1 to 240) |
| CONTROL + Q | - Set overall velocity (1 to 127) |
| CONTROL + W | - Set relative velocity |
| CONTROL + RIGHT ARROW | - Move |
| CONTROL + Y | - Extract ("uncombine") |

JUMP/RETURN COMMANDS:

- | | |
|----------------------|---|
| SHIFT + RIGHT ARROW | - Enter a Jump command |
| SHIFT + LEFT ARROW | - Enter a Return command |
| CONTROL + LEFT ARROW | - Add Return command to a track |
| CONTROL + T | - Filter (or erase) Jump / Return commands from a track |

Play/Record ENABLE/DISABLE:

- CONTROL + F - Playback enable
- CONTROL + G - Record enable
- v= Voice program changes
- p= Pitch wheel
- c= MIDI controllers
- s= MIDI clock start / stop
- SHIFT + Y - Toggle After Touch record enable

INSTANT TRANSPOSE:

- SHIFT + W - Increment Instant Transpose by half steps
- SHIFT + Q - Decrement Instant Transpose by half steps
- SHIFT + R - Increment MIDI channel to not be affected by IT
- SHIFT + E - Decrement MIDI channel to not be affected by IT

THRU:

- CONTROL + H - Decrement thru channel
- CONTROL + J - Increment thru channel

MIDI FILTER:

- CONTROL + K - Decrement record channel
- CONTROL + L - Increment record channel

TEST TONES:

- SHIFT + U - Send test tones on current MIDI channel
- SHIFT + I - Send test tones on all MIDI channels, one at a time

MIDI REMOTE COMMANDS:

- SHIFT + K - Decrement current MIDI channel
- SHIFT + L - Increment current MIDI channel
- Z - Decrement program # and send on current MIDI channel
- X - Increment program # and send on current MIDI channel
- SHIFT + C - Send program # on current MIDI channel
- SHIFT + V - Enter program # and send on current MIDI channel
- B - Decrement program # and send on all MIDI channels
- N - Increment program # and send on all MIDI channels
- C - Send program # on all MIDI channels
- SHIFT + B - Enter program limit #

MIDI MODE COMMANDS:

SHIFT + A	- Send an omni off command on the current MIDI channel
SHIFT + S	- Send an omni on command on the current MIDI channel
SHIFT + D	- Send a mono command on the current MIDI channel
SHIFT + F	- Send a poly command on the current MIDI channel
SHIFT + H	- Send omni off and poly on commands on all channels
SHIFT + O	- Send a local off command on the current MIDI channel
SHIFT + P	- Send a local on command on the current MIDI channel
SHIFT + G	- Send an all notes off command on the current MIDI channel
SHIFT + J	- Zero mod and pitch wheels on all MIDI channels
SHIFT + M	- Send MIDI Tune Request

NAMING:

CONTROL + S	- Enter name for song
CONTROL + N	- Enter name for current track

DISK OPERATIONS:

CONTROL + SHIFT + H	- Disk directory
CONTROL + SHIFT + F	- Save song onto disk
CONTROL + SHIFT + G	- Recall song from disk
CONTROL + SHIFT + ,	- Format a new disk
CONTROL + SHIFT + N	- Backup the MidiTrack III program
SHIFT + ,	- Decrement selected disk drive
SHIFT + .	- Increment selected disk drive

MISCELLANEOUS:

SHIFT + SPACE	- Locates to ST and waits for SPACE BAR to start
CONTROL + SPACE	- Locates to ST (in Single Step mode)
TAB	- Stop or continue clock
CONTROL + TAB	- Single step a clock
SHIFT + TAB	- Single step a beat
CONTROL + /	- Sets variable step (1 to 96)
/	- Increments by variable step
SHIFT + INVERSE VIDEO	- Save to current track
SPACE BAR	- Restart song
RETURN	- Stop and turn all notes off
CONTROL + X	- Turn all notes off
SHIFT + N	- Notes display
CONTROL + DELETE	- Total reset

APPENDIX C: Specification for Joystick Connection

Atari Joystick port #2

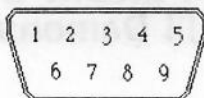

(looking at computer)

<u>Pin</u>	<u>Function</u>	
1	Clock In	-Normally high, active low
2	Beat In	-Normally high, active low
3	Clock Out	-Normally high, low pulse approx. 50 usec. long
4	Beat Out	-Normally high, low pulse approx. 5 clocks long
5	Not used	
6	Not used	
7	+5 volts	-Can be used for minor peripheral electronics
8	Ground	-Used as signal reference
9	Not used	

24 clock = 1 beat = 1/4 note.

Inputs are sampled only if Sync=joy. Sampling happens approximately 500 times a second (every 2 ms).

Outputs are always active, no matter what sync MidiTrack III is in.

Caution should be taken when wiring a connector for either joystick port.

Insert the connector into the joystick port with care. Never permit pin 7 to make contact with pin 8.

The use of a plastic connector is recommended, to eliminate the possibility that contact with the casing of a metal connector might cause an electrical short, which could result in damage to the computer. To get this hard-to-find plastic connector, cannibalize a cheap joystick with a plastic connector.

Note: The clock input and output available at both joystick ports is not affected by the External Divider and is, therefore, always set at 24 clocks per beat.

APPENDIX D: The MidiTrack III Demonstration Songs

To recall the MidiTrack Demo songs from the MidiTrack Master Disk, while holding down CONTROL and SHIFT, hit G (CONTROL + SHIFT + G). The demos are as follows:

TRACK: #	NAME	DESCRIPTION OF TRACK CONTENTS
1	0	Short 10 bar phrase, at BPM=240.
2	40 J1	10 bar phrase on track 1, repeated at BPM=400.
3	1100 J1	10 bar phrase on track 1, moved to T=1100.00.
4	All Loop	Track 1, looped indefinitely.
5	tempo cg	This track contains all tempo changes for all songs.
6		<i>Empty track.</i>
7	Xmas sng	Medley of Christmas songs.
8	100	A 3-minute pop song, which starts at T=100, by R. Moore.
9		<i>Empty track.</i>
10		<i>Empty track.</i>
11	ptchg 1	Patch changes for all tracks, MIDI channel # 1.
12	ptchg 2	" " " " " " " # 2.
13	ptchg 3	" " " " " " " # 3.
14	ptchg 4	" " " " " " " # 4.
15	440	Mozart Sonatina, performed by Julie Dancz; at T=440)
16	750	Bach Prelude & Fugue, performed by Julie Dancz; at T=750.

In order to hear tracks 4 and 7, it is first necessary to individually solo each track by selecting track number 4 or 7, respectively; then, while holding down SHIFT, hit the UP ARROW key (SHIFT + UP ARROW). These demonstration songs will play back on MIDI Channels 1 through 4.

GLOSSARY

active low/active high:

A low voltage level in a computer logic circuit, equivalent to 0 V (Volts), represents a binary 0. A Start signal is generally active low. A high voltage level, equivalent to 5V, represents a binary 1. A Stop signal is generally active high.

ASCII:

An acronym for American Standard Code for Information Interchange. A standard code used to implement the exchange of digital information among microprocessor-based devices, the ASCII character code is made up of 128 binary numbers, which represent control characters and the characters of an alphanumeric computer keyboard.

auto-correction:

See Quantization.

Auto-Location:

The automatic location of a user-designated Start point in a song, permitting playback to begin at any point in a song.

baud:

A unit of measure for data transmission speed. According to common usage, the baud rate is considered to be equivalent to the number of bits transmitted per second. Technically, the baud rate may be defined as the number of discrete changes of status in the communications line per second.

beat:

The basic division of time available in sequencing instruments, designated as Beats Per Minute. In MidiTrack III, each beat is equivalent to a quarter note and is divided into 24 clocks.

Beats Per Minute (BPM):

The BPM setting establishes the tempo at which a song is to be played.

binary:

A Base 2 numbering system, universally employed in digital computers, in which each binary number is composed of ones and zeros. Pertaining to the selection of, or a condition which has, two opposite values or states, each represented by the digit one (on, yes, high) or zero (off, no, low). The digit one represents the presence of voltage; zero, the absence of voltage.

bit:

An acronym for binary digit. The smallest unit of digital information. A single digit in a binary number. The status of a bit is either 1/on or 0/off. Eight bits comprise a byte.

boot:

To load and run a software program. The program initializes or sets up the status of the computer, clearing memory registers, setting up the I/O (Input/Output) devices, loading the operating system and setting counters and software switches to their default or starting values.

bounce:

To transfer several previously recorded tracks to a single open track.

buffer:

A location in RAM (Random Access Memory) that is temporarily dedicated to a specific task or reserved for use as an intermediate storage area into which data is read or from which data is written when performing an Input/Output operation; for example, copying song data from a source track to a destination track.

byte:

A unit of digital information, consisting of eight bits, which represents a single letter or other ASCII character. A digital word may be made up of one, two or three bytes.

clock:

The smallest division of time available in a sequencing instrument. In MidiTrack III, 24 clocks make up one beat. A reference timing device in a microprocessor-based system which generates periodic signals, or pulses occurring precisely at equal intervals of time, to which other devices may be synchronized. See master clock.

clock rate:

The rate in time at which periodic pulses are generated by a clock varies according to the BPM setting selected.

clock standards:

The common time base for standard clocks is 24 clocks per beat. The standard clocks are multiples of this 24-clocks-per-beat time base, such as 48 or 96 clocks per beat.

cue:

Auto-location to a Start Point at which playback will begin.

daisy chain:

A signal path created by interconnecting devices in such a way that a signal or data stream may be passed serially from one device to another.

Data byte:

A MIDI byte, in which the Most Significant Bit (MSB) is a zero, containing data which is interpreted according to the preceding Status byte.

decrement:

To decrease a numerical value by one.

default:

The initial value, status or selection implemented when a software program is loaded. The value assumed for a parameter when no other value has been specified by the user.

destination track:

The track to which the contents of the record/edit buffer is to be saved.

digital:

Pertaining to data stored as binary digits, or a quantized representation of an analog signal.

digital word:

A character set, or bit string, which occupies a single location in memory and is treated as a unit.

disk:

A non-volatile, magnetic storage medium, in the form of a "floppy" disk, upon which digital data files may be stored.

disk track:

One of a set of concentric circles on a magnetic disk, which may be accessed by the read/write head of a disk drive as the disk rotates. Each track is comprised of a string of sectors. The data storage capacity of each track is established by the computer's DOS (Disk Operating System) upon disk formatting and is uniform for all tracks. See sector.

DOS:

An acronym for Disk Operating System. A program which controls the transfer of data to and from the computers RAM (Random Access Memory) and implements the storage of data on a floppy or hard disk.

durate:

To change the duration of all notes on a track to the same value.

filter:

To separate and remove specified data from a data stream on input or output.

format:

To implement a procedure which establishes the layout of track sectors on a disk.

increment:

To increase a numerical value by one.

interrupt:

A temporary suspension of the normal sequence of a process being executed, generally initiated by an interrupt request signal received from a source external to that process, allowing the computer to go into an interrupt handling routine. When the interrupt handling routine has been executed, the process suspended will be resumed at the point at which it was interrupted.

kilobaud:

A thousand bits per second. A unit of measure for data transmission speed. See baud.

looping:

The repetition of a section of a track, implemented without the use of additional memory. The repetitive execution of the same set of instructions. On execution, a loop control statement specifies the instructions to be executed under control of the loop, the parameters governing the execution of the loop and the location to which control is passed upon termination of the loop.

master clock:

An internal clock generated by the master controller of a system to which slave instruments may be synchronized. In MidiTrack III, when Internal Sync has been selected, the master clock pulse generated by MidiTrack III permits the synchronization of an entire system.

microprocessor:

An integrated circuit, or microchip, capable of processing the digitally encoded instructions comprising a program. In a microcomputer, the central processing unit, or CPU.

MIDI:

An acronym for Musical Instrument Digital Interface, which permits communication between personal computers and microprocessor-based keyboard instruments, synthesizers, controller keyboards, drum machines, sequencers and signal processors.

MIDI byte:

A digital word made up of a start bit, eight data bits and a stop bit. A MIDI receiving device strips off the start and stop bits, then processes the incoming MIDI data.

MIDI Channel:

A MIDI data stream generated by a MIDI instrument or sequencer may be assigned to any of the 16 MIDI Channels (numbered 1 through 16) designated by the MIDI specification. Each MIDI Channel permits the transmission and reception of a discrete MIDI data stream, and may be used to selectively address individual instruments in a MIDI system. In MidiTrack III, MIDI data may be simultaneously transmitted and received via all 16 MIDI Channels.

MIDI clock:

A clock signal sent and received by all MIDI devices which is equivalent to 24 clocks per beat. See clock and master clock.

MIDI event:

Each MIDI message constitutes a discrete MIDI event. MIDI events include Note-On (including Velocity information), Note-Off, After-Touch data, Pitch-Bend data, Controller data and Program Change.

MIDI In:

A port through which MIDI data is received.

MIDI message:

A Status byte followed by one or two Data bytes. See Data byte and Status byte.

MIDI Out:

Only MIDI data originating in a MIDI device will be transmitted via its MIDI Out port.

MIDI Thru:

Outputs a MIDI data stream identical to that received at its MIDI In.

Mono Mode:

When selected, Mono Mode will cause an instrument to respond monophonically.

monophonic:

Capable of generating a single voice; that is, one note at a time.

Most Significant Bit (MSB):

A bit in the left-most position in a binary number, or digital word, which has the greatest numerical weight.

Mute:

To temporarily turn off, or defeat, the audio output for a given track.

Omni-Off Mode:

When selected, Omni-Off Mode will cause an instrument to receive only those MIDI messages sent on the MIDI Channel to which it is assigned.

Omni-On Mode:

When selected, Omni-On Mode will cause an instrument to receive MIDI messages on all MIDI Channels.

Poly Mode:

When selected, Omni-On Mode will cause an instrument to respond polyphonically.

polyphonic:

Having a sound architecture capable of generating more than one voice; that is, several notes at a time.

post-roll:

When punching, the portion of a song played back after the Punch-Out Point and up to the End Point.

pre-roll:

When punching, the portion of a song played back beginning at the Start Point and prior to the Punch-In Point.

protocol: A set of rules, or conventions, governing communication between microprocessor-based devices, which establishes, in software, a standard for the transfer of data. The parameters specified by a communication protocol generally include the rate of transmission, format and content of the digital messages being exchanged.

Punch In/Punch Out Editing:

Inserting new MIDI song data on a specified part of an existing track, overwriting the data currently residing on the section of the track that falls between the Punch-In and Punch-Out Points.

Quantization:

Also known as auto-correction or error-correction. The correction of rhythmic inaccuracies in a sequence entered in real time effected by selecting the degree of accuracy with which each beat will be played back, known as the Quantization Value, which may be equivalent to various note durations.

quantized:

Represented by discrete, discontinuous digital values.

RAM:

An acronym for Random Access Memory, the computer's internal memory, the contents of which may be accessed directly by specifying an address or memory location. The computer's DOS transfers programs and data files to and from RAM. RAM is volatile, read/write memory. The contents of RAM may be changed or written to at any time.

real time:

Pertaining to a data processing application in which output is generated at the same rate at which data is input via human intervention. Real-time applications do not require intermediate storage in a buffer.

register:

A memory location, designated for specialized applications, which has a specified storage capacity, such as a bit, byte or digital word.

resolution:

The degree of accuracy, determined by the number of bits in each digital word, with which an analog signal may be reproduced. Computers store continuously variable, analog signals as digital data comprised of a series of discrete, quantized values. The finer the resolution of these quantized values, the more accurate the representation of the analog signal. MidiTrack III has a resolution of 24 clocks per beat.

ROM:

An acronym for Read-Only Memory, a form of internal memory which is permanently dedicated to specific functions and is nonvolatile. The programs residing in ROM may not be overwritten or modified.

routine:

An algorithm, or set of coded instructions arranged in sequence, which may be called by a program to direct the computer to perform a given operation or series of operations.

sector:

A portion of a track on a magnetic disk upon which data may be stored. The size and location of each track sector, and the number of disk blocks contained in each sector are defined by the computer's DOS (Disk Operating System) upon formatting. A sector is the smallest possible unit of disk storage space. A file may occupy many track sectors, but each file sector may contain only one file. The track sectors on a disk are accessed through reference to the disk's Volume Table of Contents (VTOC), or disk directory, which resides on a track designated by DOS. See disk track.

SMPTE time code:

A reference time code, which conforms to a standard established by the Society of Motion Picture and Television Engineers, used to permit the synchronization of two or more devices, including audio and video recorders, and digital sequencers. SMPTE time code is recorded over the length of a single track of a multitrack tape as a digitally-encoded data stream, in which each recorded frame is assigned and identified by a unique 80-bit digital word, which defines the hour, minute, second and frame number for each frame.

Solo:

To enable audio output for an individual track on playback, while temporarily muting or disabling audio output for all tracks not soloed.

Song Position Pointer (SPP):

A signal output by a MIDI device providing the master clock for a MIDI system that communicates the precise point in a MIDI sequence at which a slave MIDI device capable of recognizing SPP, such as a drum machine or sequencer, should start or stop.

source track:

A track containing song data which is to be transferred, via the record/edit buffer, to a selected destination track.

Star Search:

Causes a master MIDI device to send a MIDI Clock signal before the selected Start Point has been reached, permitting the master and slave MIDI devices to synchronize and start playback simultaneously.

Status byte:

A MIDI byte, in which the Most Significant Bit (MSB) is a one, that communicates to the MIDI receiver how the MIDI Data bytes which follow should be interpreted.

Step Edit Mode:

A MIDI data entry or editing mode in which you may advance by steps (clocks and/or beats) to a specific point in a MIDI sequence, then enter MIDI events individually.

Track:

In MidiTrack III, a track is analogous to a track on a multitrack tape.

TTL:

Transistor Transistor Logic: A universal clock output, standard for microprocessor-based devices, which outputs the digital equivalent of a voltage pulse or square wave, with a low state at 0V (Volts) and a high state at 5V. The Start signal is active low; that is, 0V. The voltage remains low while the TTL clock is being transmitted. The Stop signal is active high: that is, 5V.

Transposition:

To change the key in which a track or an entire song was recorded to another user-designated key on playback.

Velocity sensitivity:

The responsiveness of a keyboard controller to the velocity with which its keys are struck, permitting Velocity information to affect an instrument's sound output; generally, its ability to reproduce dynamics. Velocity information may be transmitted via MIDI to affect tone production on another MIDI instrument or to enable it to be recorded by a MIDI sequencer.

voice:

In a synthesizer's sound architecture, a tone produced by a group of components capable of generating a single tone at a time. The number of voices available on an instrument determines its polyphony or the number of notes which may be played simultaneously.

volatile memory:

A form of memory in which the data contained is lost when power is removed from a microprocessor-based system.

write-protection:

The protection of tracks or songs residing in memory, implemented in software, to prevent their accidental erasure. A write-protected track or song may not be altered; that is, you cannot write or save any data to write-protected memory.

INDEX

After touch filter indicator.....	26	Naming (songs).....	19
All notes off command.....	68	Naming (tracks).....	19
Auto-Location.....	47	Note activity indicator.....	20
Automated mixing.....	76	Note display.....	69
		Note duration (editing).....	64
		Note off.....	77
		Note on.....	77
Beats per minute.....	23		
Beat Sync.....	40	Omni Off mode.....	67
		Omni On mode.....	67
Chaining (tracks).....	56		
Change indicator.....	21	Paste.....	10
Channel Messages.....	77	Percentage of memory used.....	23
Combining tracks.....	42	Pitch bend R/P indicator.....	26
Copying (songs).....	15	Playback.....	32
Copying (tracks).....	42	Playback/Record mode.....	32
Copy & Paste.....	56	Play/Record MIDI functions ind.....	26
Current MIDI Channel.....	29	Poly mode.....	67
Current Voice Patch.....	29	Programming Start/Stop/Cont.....	39
		Programmable step value.....	24,37
Deleting tracks.....	42	Punch In/Out mode.....	50,51,52
Digital Delay.....	56	Punch In/Out indicators.....	25
Digital Delay programming.....	56	Punch In point (programming).....	50
Disk Directory.....	15	Punch Out point (programming).....	51
Disk Drive Indicator.....	31	Punch track indicator.....	25
Disk errors.....	16		
Disk formatting.....	13	Quantization.....	45
Disk handling.....	16		
Drum machine sync.....	74	Recalling (songs from disk).....	14
		Record/Playback mode.....	32
Echo effect.....	56	Remote Voice Patch selection.....	29
Edit Buffer.....	9	Reset.....	69
End point indicator.....	25	Return indicator.....	21
End point (programming).....	25	Roland Sync.....	40
Errors (disk).....	16		
Exclusive Messages.....	77	Saving tracks.....	32
External Divider.....	35	Saving (songs to disk).....	14
External Divider Indicator.....	26	Selecting tracks.....	19
External Sync.....	35	SMPTC time code.....	75
Extracting tracks.....	43	Solo (tracks).....	20
		Song building with Jump/Return.....	61
Formatting (disks).....	13	Song Position Pointer.....	9,38
"Hung" notes.....	65	Song Position Pointer indicator.....	24
		Song reset.....	69
Instant transposition.....	44	Song revision number.....	19
Internal Sync.....	34	Star Search.....	38
Instant transposition indicator.....	25	Star Search indicator.....	24
		Start point.....	47
Joystick sync.....	40	Start point (programming).....	47
Jump indicator.....	21	Start/Stop/Cont. indicator.....	26
Jump/Return command.....	57	Start/Stop polarity indicator.....	26
		Step edit mode.....	37,54
Local OFF command.....	68	Step value.....	24
Local ON command.....	68	Step value programming.....	54
		System messages.....	77
Memory limit indicator.....	31	Sync modes.....	34
Memory (remaining).....	31	Sync mode indicator.....	26
Metronome indicator.....	26	Sync track (recording).....	36
MIDI.....	77		
MIDI Channel assignment.....	21	Tape sync.....	74
MIDI Clock sync.....	38	Tempo change indicator.....	24
MIDI Controller Record/ Playback indicator.....	26	Tempo changes (programming).....	34
MIDI Message.....	77,78	Test Tone.....	67
MIDI mode selection.....	67		
MIDI Record Ch. indicator.....	31	Velocity.....	63
MIDI thru.....	25	Velocity Changes (relative).....	63
MIDI thru mode.....	25	Voice Patch Change Indicator.....	26
MIDI thru ch. indicator.....	25	Voice Patch Change.....	26,29
MIDI tune request.....	67	Voice Patch Limit.....	30
MIDI volume.....	76		
Mono mode.....	68	Waiting Indicator.....	26
Move command.....	56	Working disks.....	13
Multiple Drive access.....	15	Write Protection (disks).....	15
Mute (tracks).....	20	Write Protection Indicator.....	22

